

## Transportation engineering

- **Transportation engineering** is the application of technology and scientific principles to the planning, functional design, operation and management of facilities for any mode of transportation in order to provide for the safe, efficient, rapid, comfortable, convenient, economical, and environmentally compatible movement of people and goods from one place to other.

## MODES OF TRANSPORTATION

- Basic mode of transportation are
  - Land
    - Roadway
    - railway
  - Water
  - Air

# MODES OF TRANSPORTATION

- **Highways**

Car, Bus, Truck, non- motorized ..etc

- **Railways**

Passenger and Goods

- **Airways**

Aircraft and Helicopters

- **Waterways**

Ships, boats...

- **Continuous Flow systems**

Pipelines,belts,elevetor,ropeway...etc.

- Merits and Demerits: Based on accessibility, mobility, cost, tonnage..

## Airways

- Fastest among all other modes
- More comfortable
- Time saving
- Uneconomical

## Waterways

- slowest among all other modes
- It needs minimum energy to haul unit load through unit distance.
- This can be possible between ports on the sea routes or along the river
- economical

## Railways

- The transportation along the railways track could be advantageous by railways between the stations both for the passengers and goods, particularly for long distance.
- It depends upon the road transport i.e. road could serve as a feeder system.
- Energy require to haul a unit load through unit distance by the railway is only  $\frac{1}{4}$  to  $\frac{1}{5}$  of that required by road.
- Safety

## Highways

- It gives the maximum service to one and all
- It gives maximum flexibility for travel with reference to route, direction, time and speed of travel
- It provide door to door service
- Other modes are depend on it
- It requires small investment for the government
- Motor vehicles are cheaper than other carriers like rail locomotive and wagons
- It saves the time for short distance
- High degree of accident due to flexibility of movement

## Scope of highway engineering

- Development, planning and location
- Highway design, geometric and structure
- Traffic performance and its control
- Materials, construction and maintenance
- Economic, finance and administration

## **ROLE /IMPACT OF TRANSPORTATION**

- Economic Development
- Social Development
- Spatial Development
- Cultural Development
- Political Development



## Characteristics of road transport

- Roads are used by various types of road vehicles, like passenger cars, buses, trucks, pedal cycle and animal drawn vehicle.
- It requires a relatively small investment for the government.
- It offers a complete freedom to road users to transfer the vehicle from one lane to another and from one road to another according to need and convenience.
- Speed and movement is directly related with the severity of accident.
- Road transport is the only means of transport that offers itself to the whole community alike.

# HISTORICAL DEVELOPMENT OF ROAD CONSTRUCTION

- Oldest mode
  - Foot paths- animal ways, cart path.....
- As civilization evolved the need for transportation increased

## ROMAN ROAD-(500 B.C.)

- They were built straight regardless of gradient
- They were built after the soft soil was removed and a hard stratum was reached.
- Thickness varies from 0.75 m to 1.2m

# Roman Road Construction

## Basic cross section

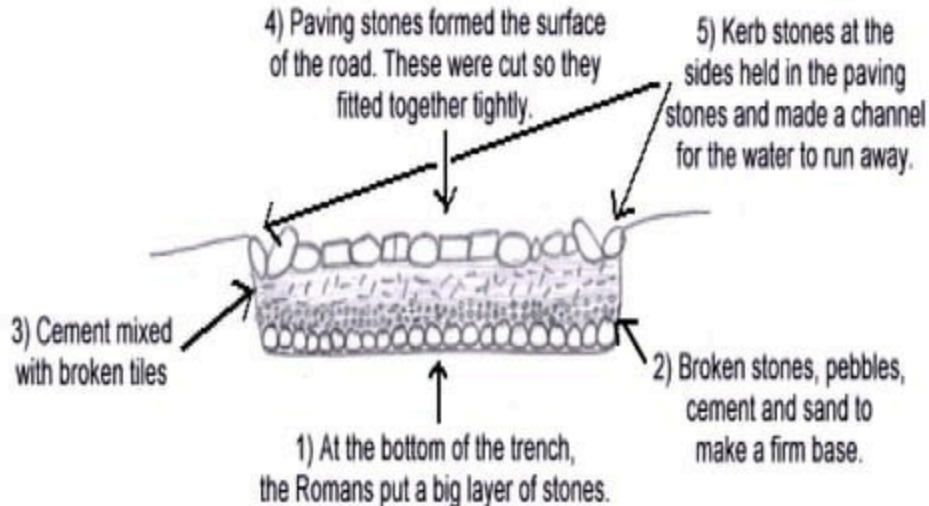



**Roman Roads**

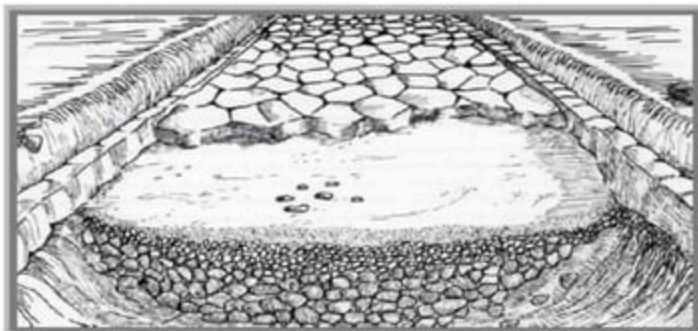

Ref. Roman Roads of Europe, NHH Sirwell, Cassell-London, 1991



**Modern Highway**

## Other oldest road transport are

- Tresaguet construction
- Metcalf construction
- Telford construction
- Mecadam construction

## Indian Roads

- India has a large road network of over 3.314 million kilometers of roadways (2.1 million miles), making it 3<sup>rd</sup> largest road network in the world.
- At 0.66 km of highway per square kilometer of land the density of India's highway network is higher than that of the United States (0.65) and far higher than that of China's (0.16) or Brazil's (0.20).

## **Highway Development in India**

- **Jayakar Committee (1927)**
- **Central Road Fund (1929)**
- **Indian Roads Congress (IRC), 1934**
- **Central Road Research Institute (CRRI), 1950**
- **Motor vehicle act (1936)**
- **National Highway Authority of India (NHAI),1995**
- **First twenty year road plan ( 1943-61 )**
- **Second twenty year road plan ( 1961-81 )**
- **Highway Research board ( 1973 )**
- **National Transport Policy committee ( 1978 )**
- **Third twenty year road plan ( 1981-2001 )**

## Jayakar Committee, 1927

- After the first World War, motor vehicle using the roads increases, this demanded a better road network.
- In 1927, Indian road development committee was appointed by the government with M.R. Jaykar as chairman.
- Road development in the country should be made as a national interest since local govt. do not have financial and technical capacity for road development.
- An extra tax should be levied on petrol from road users to create the road development fund.
- To establish a semi-official ,technical institution to pool technical knowledge, sharing of ideas and to act as an advisory body.
- To create a national level institution to carry research , development works and consultation.



## Central road fund

- It was formed on 1<sup>st</sup> march 1929
- The consumers of petrol were charged an extra levy of 2.64 paise per litre of petrol to built up this road development fund.
- From this 20% of annual revenue is to be retain as a central revenue for research and experimental work expenses..etc
- Balance 80% is allowed by central govt. to various states based on actual petrol consumption or revenue collected.

# Central Road Fund , 1929

## CRF Act , 2000

Distribution of 100% cess on petrol as follows:

- 57.5% for NH
  - 30% for SH
  - 12.5% for safety works on rail-Road crossing.
- } **MORTH**

50% cess on diesel for Rural Road development

## Indian Roads Congress, 1934

- Central semi official body known as IRC was formed in 1934.
- To provide national forum for regular pooling of experience and ideas on matters related to construction and maintenance of highways.
- It is a active body controlling the specification, standardization and recommendations on materials, design of roads and bridges.
- It publishes journals, research publications and standard specifications guide lines.
- To provide a platform for expression of professional opinion on matters relating to roads and road transport.

## **Motor vehicle act**

- It was formed in 1939
- To regulate the road traffic in the form of traffic laws, ordinances and regulations.
- Three phases primarily covered are control of driver, vehicle ownership and vehicle operation
- It was revised on 1988

## Central road research institute(1950)

- engaged in carrying out research and development projects.
- design, construction and maintenance of roads and runways, traffic and transportation planning of mega and medium cities, management of roads in different terrains,
- Improvement of marginal materials.
- Utilization of industrial waste in road construction.
- Landslide control.
- Ground improvements, environmental pollution.
- Road traffic safety.

## Ministry of Road Transport & Highways

- Planning, development and maintenance of National Highways in the country.
- Extends technical and financial support to State Governments for the development of state roads and the roads of inter-state connectivity and economic importance.
- Evolves standard specifications for roads and bridges in the country.
- It stores the data related to technical knowledge on roads and bridges.

## Highway Research Board

- To ascertain the nature and extent of research required
- To correlate research information from various organisation in India and abroad.
- To collect and correlation services.
- To collect result on research
- To channelise consultative services

# Classification of Highways

## Depending on weather

- All weather roads
- Fair weather roads

## Depending the type of Carriage way

- Paved roads(WBM)
- Unpaved roads(earth road or gravel road)

## Depending upon the pavement surface

- Surfaced roads(bituminous or cement concrete road)
- Un surfaced roads



# Classification of Highways

## Based on the Traffic Volume

- Heavy
- Medium
- Light

## Based on Load or Tonnage

Class 1 or Class 2 etc or Class A , B etc Tonnes per day

## Based on location and function ( Nagpur road plan )

- National highway (NH)
- State highway (SH)
- Major district road (MDR)
- Other district road (ODR)
- Village road (VR)

# Based on modified system of Highways classification

- **Primary**
  - Expressways
  - National Highways
- **Secondary**
  - SH
  - MDR
- **Tertiary**
  - ODR
  - VR

## Expressways

- Heavy traffic at high speed (120km/hr)
- Land Width (90m)
- Full access control
- Connects major points of traffic generation
- No slow moving traffic allowed
- No loading, unloading, parking.



The Mumbai-Pune Expressway as seen from Khandala

## National Highways

- NH are the main highways running through the length and breadth of India, connecting major parts, foreign highways, capital of large states and large industrial and tourist centres including roads required for strategic movements for the defence of India.
- The national highways have a total length of 70,548 kms. Indian highways cover 2% of the total road network of India and carry 40% of the total traffic.
- The highway connecting Delhi-Ambala-Amritsar is denoted as NH-1, whereas a bifurcation of this highway beyond Jalandar to Srinagar and Uri is denoted NH-1-A
- The longest highway in India is NH7 which stretches from Varansi in Uttar Pradesh to Kanyakumari in the southern most point of Indian mainland.

## National Highways cont...

- The shortest highway is NH47A which stretches from Ernakulam to Kochi and covers total length of 4 Kms.
- **Golden Quadrilateral** – (5,846 Km)  
**Kolkata-Chennai-Mumbai**
  - NH-2 Delhi- Kol (1453 km)
  - NH 4,7&46 Che-Mum (1290km)
  - NH5&6 Kol- Che (1684 m)
  - NH 8 Del- Mum (1419 km)



## State Highways

- They are the arterial roads of a state, connecting up with the national highways of adjacent states, district head quarters and important cities within the state.
- Total length of all SH in the country is 1,37,119 Kms.
- Speed 80 kmph

## Major District Roads

- Important roads with in a district serving areas of production and markets , connecting those with each other or with the major highways.
- India has a total of 4,70,000 kms of MDR.
- Speed 60-80kmph

## Other district roads

- serving rural areas of production and providing them with outlet to market centers or other important roads like MDR or SH.
- Speed 50-60kmph

## Village roads

- They are roads connecting villages or group of villages with each other or to the nearest road of a higher category like ODR or MDR.
- India has 26,50,000 kms of ODR+VR out of the total 33,15,231 kms of all type of roads.
- Speed-40-50kmph



## Urban Road Classification

- Arterial Roads
- Sub Arterial
- Collector
- Local Street
- Cul-de-sac
- Pathway
- Driveway

# ARTERIAL

- No frontage access, no standing vehicle, very little cross traffic.
- Design Speed : 80km/hr
- Land width : 50 – 60m
- Divided roads with full or partial parking
- Pedestrian allowed to walk only at intersection

## SUB ARTERIAL ROAD

- Bus stops but no standing vehicle.
- Less mobility than arterial.
- Spacing for CBD : 0.5km
- Design speed : 60 km/hr
- Land width : 30 – 40 m

## Collector Street

- Collects and distributes traffic from local streets
- Provides access to arterial roads
- Located in residential, business and industrial areas.
- Full access allowed.
- Parking permitted.
- Design speed : 50km/hr
- Land Width : 20-30m

## Local Street

- Design Speed : 30km/hr.
- Land Width : 10 – 20m.
- Primary access to residence, business or other abutting property
- Less volume of traffic at slow speed
- Unrestricted parking, pedestrian movements. (with frontage access, parked vehicle, bus stops and no waiting restrictions)

## CUL-DE-SAC

- Dead End Street with only one entry access for entry and exit.
- Recommended in Residential areas



## Driveway

- A driveway is a type of private road for local access to one or a small group of structures, and is owned and maintained by an individual or group.
- Driveways are commonly used as paths to private garages, fuel stations, or houses

## Road Patterns

- Rectangular or Block patterns
- Radial or Star block pattern
- Radial or Star Circular pattern
- Radial or Star grid pattern
- Hexagonal Pattern
- Minimum travel Pattern



## First 20-years road plan(1943-63)

- The conference of chief engineer held at Nagpur in 1943 finalized the first 20-years road development plan for India called Nagpur road plan
- Road network was classified into five categories.
- The responsibility of construction maintenance of NH was assign to central govt.
- The target road length was 5,32,700 km at the end of 1961.
- Density of about 16km of road length per 100 sq. km area would be available in the country by the year 1963.

## First 20-years road plan cont...

- The formulae were based on star and grid pattern of road network.
- An allowance of 15% is provided for agricultural industrial development during the next 20-years
- The length of railway track in the area was also consider in deciding the length of first category road. The length or railway track is directly subtracted from the estimated road length of metalled roads.

## Second 20-years road plan(1961-81)

- It was initiated by the IRC and was finalised in 1959 at the meeting of chief engineers.
- It is known as the Bombay road plan.
- The target road length was almost double that of Nagpur road plan i.e. 10,57,330 km.
- Density about 32 km per 100 sq. km. and an outlay of 5200 crores
- Every town with population above 2000 in plains and above 1000 in semi hill area and above 500 in hilly area should be connected by metalled road

## Second 20-years road plan cont...

- the maximum distance from any place in a semi develop area would be 12.8 km from metalled road and 4.8 from any road
- Expressways have also been considered in this plan and 1600km of length has been included in the proposed target NH
- Length of railway track is considered independent of road system
- 5% are to be provided for future development and unforeseen factor

## Third twenty years road plan (1981-2001)

- The future road development should be based on the revised classification of roads system i.e. primary, secondary and tertiary
- Develop the rural economy and small towns with all essential features.
- Population over 500 should be connected by all weather roads.
- Density increases to 82 km per 100 sq. km
- The NH network should be expanded to form a square grids of 100 km sides so that no part of the country is more than 50 km away from the NH

## Third twenty years road plan cont...

- Expressway should be constructed along major traffic corridors
- All towns and villages with population over 1500 should be connected by MDR and villages with population 1000-1500 by ODR.
- Road should be built in less industrialized areas to attract the growth of industries
- The existing roads should be improved by rectifying the defects in the road geometry, widening, riding quality and strengthening the existing pavement to save vehicle operation cost and thus to conserve energy

# Highway alignment and surveys

## Highway alignment

- The position or lay out of centre line of the highway on the ground is called the alignment.
- It includes straight path, horizontal deviation and curves.
- Due to improper alignment, the disadvantages are,
  - Increase in construction
  - Increase in maintenance cost
  - Increase in vehicle operation cost
  - Increase in accident cost
- Once the road is aligned and constructed, it is not easy to change the alignment due to increase in cost of adjoining land and construction of costly structure.







## Requirements of highway alignment

- Short
  - Easy
  - Safe
  - Economical
- 
- Short- desirable to have a short alignment between two terminal stations.
  - Easy- easy to construct and maintain the road with minimum problem also easy for operation of vehicle.
  - Safe- safe enough for construction and maintenance from the view point of stability of natural hill slope, embankment and cut slope also safe for traffic operation.
  - Economical- total cost including initial cost, maintenance cost and vehicle operation cost should be minimum.

# Factors controlling alignment

- Obligatory points
- Traffic
- Geometric design
- Economics
- Other considerations

## Additional care in hill roads

- Stability
- Drainage
- Geometric standards of hill roads
- Resisting length

# Factors controlling alignment cont...

## Obligatory points

- Obligatory points through which alignment is to pass  
Examples:-bridge site, intermediate town , Mountain pass etc...
- Obligatory points through which alignment should not pass.  
Examples:-religious places, costly structure, unsuitable land etc...

## Traffic

- origin and destination survey should be carried out in the area and the desire lines be drawn showing the trend of traffic flow.
- New road to be aligned should keep in view the desired lines, traffic flow patterns and future trends.

## Geometric design

- Design factors such as gradient ,radius of curve and sight distance also govern the final alignment of the highway.
- Gradient should be flat and less than the ruling gradient or design gradient.
- Avoid sudden changes in sight distance, especially near crossings
- Avoid sharp horizontal curves
- Avoid road intersections near bend

### Economy

- Alignment finalised based on total cost including initial cost, maintenance cost and vehicle operation cost.

### Other consideration

- Drainage consideration, political consideration
- Surface water level, high flood level
- Environmental consideration

## Topographical control points

- The alignment, where possible should avoid passing through
  - Marshy and low lying land with poor drainage
  - Flood prone areas
  - Unstable hilly features

## Materials and constructional features

- Deep cutting should be avoided
- Earth work is to be balanced; quantities for filling and excavation
- Alignment should preferably be through better soil area to minimize pavement thickness
- Location may be near sources of embankment and pavement materials

## **stability**

- A common problem in hilly roads is land sliding
- The cutting and filling of the earth to construct the roads on hilly sides causes steepening of existing slope and affect its stability.

## **Drainage**

- Avoid the cross drainage structure
- The number of cross drainage structure should be minimum.

## **Geometric standard of hilly road**

- Gradient, curve and speed
- Sight distance, radius of curve

## **Resisting length**

- The total work to be done to move the loads along the route taking horizontal length, the actual difference in level between two stations and the sum of the ineffective rise and fall in excess of floating gradient. Should kept as low as possible.



# Engineering Surveys for Highway locations

Before a highway alignment is finalised in highway project, the engineering survey are to be carried out. The various stages of engineering surveys are

- **Map study** (Provisional alignment Identification)
- **Reconnaissance survey**
- **Preliminary survey**
- **Final location and detailed surveys**

## MAP STUDY

- From the map alternative routes can be suggested in the office, if the topographic map of that area is available.
- The probable alignment can be located on the map from the following details available on the map.
  - Avoiding valleys, ponds or lake
  - Avoiding bend of river
  - If road has to cross a row of hills, possibility of crossing through mountain pass.
- Map study gives a rough guidance of the routes to be further surveyed in the field

## RECONNAISSANCE SURVEY

- To confirm features indicated on map.
- To examine the general character of the area in field for deciding the most feasible routes for detailed studies.
- A survey party may inspect along the proposed alternative routes of the map in the field with very simple instrument like abney level, tangent clinometer, barometer etc.... To collect additional details.
- Details to be collected from alternative routes during this survey are,
  - Valleys, ponds, lakes, marshy land, hill, permanent structure and other obstruction.
  - Value of gradient, length of gradient and radius of curve.

## RECONNAISSANCE SURVEY cont..

- Number and type of cross drainage structures.
- High Flood Level (HFL)
- Soil Characteristics.
- Geological features.
- source of construction materials- stone quarries, water sources.
- Prepare a report on merits and demerits of different alternative routs.
- As a result a few alternate alignments may be chosen for further study based on practical considerations observed at the site.

# Preliminary survey

## Objective of preliminary survey are:

- To survey the various alternative alignments proposed after the reconnaissance and to collect all the necessary physical information and detail of topography, drainage and soil.
- To compare the different proposals in view of the requirements of the good alignment.
- To estimate quantity of earthwork materials and other construction aspect and to workout the cost of the alternate proposals.

## Methods of preliminary survey:

- a) Conventional approach-survey party carries out surveys using the required field equipment, taking measurement, collecting topographical and other data and carrying out soil survey.

## Preliminary survey cont...

- Longitudinal and cross sectional profile.
  - Plain Terrain` : 100 – 200m
  - Rolling Terrain : 50m
  - Hilly Terrain : 30m
- Other studies
  - Drainage, Hydrological survey, soil survey, Traffic and Material survey.

### b) Modern rapid approach-

By Aerial survey taking the required aerial photographs for obtaining the necessary topographic and other maps including details of soil and geology.

- Finalise the best alignment from all considerations by comparative analysis of alternative routes.

## Final location and detailed survey

- The alignment finalised at the design office after the preliminary survey is to be first located on the field by establishing the centre line.

### Location survey:

- Transferring the alignment on to ground.
- This is done by transit theodolite.
- Major and minor control points are established on the ground and centre pegs are driven, checking the geometric design requirements.
- Centre line stacks are driven at suitable intervals, say 50m interval in plane and rolling terrains and 20m in hilly terrain.

## Final location and detailed survey cont..

### Detailed survey:

- Temporary bench marks are fixed at intervals of about 250m and at all drainage and under pass structure.
- Earthwork calculations and drainage details are to be workout from the level books.
- Cross sectional levels are taken at intervals of 50-100m in **Plane terrain**, 50-75m in **Rolling terrain**, 50m in **built-up area**, 20m in **Hill terrain**.
- Detail soil survey is to be carried out.
- CBR value of the soils along the alignment may be determined for design of pavement.
- The data during detailed survey should be elaborate and complete for preparing detailed plans, design and estimates of project.



## Drawing and Report

- Key map
- Index map
- Preliminary survey plans
- Detailed plan and longitudinal section
- Detailed cross section
- Land acquisition plans
- Drawings of cross drainage and other retaining structures
- Drawings of road intersections
- Land plans showing quarries etc

## New highway project

- Map study
- Reconnaissance survey
- Preliminary survey
- Location of final alignment
- Detailed survey
- Material survey
- Geometric and structural design
- Earth work
- Pavement construction
- Construction controls

## Bibliography

- Khanna, S. K., & Justo, C. E. G. *Highway engineering. Nem Chand & Bros.*
- *IRC Codes.*

## Importance of geometric design

- The geometric design of a highway deals with the dimensions and layout of visible features of the highway such as alignment, sight distance and intersection.
- The main objective of highway design is to provide optimum efficiency in traffic operation with maximum safety at reasonable cost.
- Geometric design of highways deals with following elements :
  - Cross section elements
  - Sight distance considerations
  - Horizontal alignment details
  - Vertical alignment details
  - Intersection elements

## Design Controls and criteria

- Design speed
- Topography
- Traffic factors
- Design hourly volume and capacity
- Environmental and other factors

### Design speed

- In India different speed standards have been assigned for different class of road
- Design speed may be modified depending upon the terrain conditions.

## topography

- Classified based on the general slope of the country.
  - Plane terrain- <10%
  - Rolling terrain- 10-25%
  - Mountainous terrain- 25-60%
  - Steep terrain- >60%

## Traffic factor

- Vehicular characteristics and human characteristics of road users.
- Different vehicle classes have different speed and acceleration characteristics, different dimensions and weight .
- Human factor includes the physical, mental and psychological characteristics of driver and pedestrian.

## Design hourly volume and capacity

- Traffic flow fluctuating with time
- Low value during off-peak hours to the highest value during the peak hour.
- It is uneconomical to design the roadway for peak traffic flow.

## Environmental factors

- Aesthetics
- Landscaping
- Air pollution
- Noise pollution

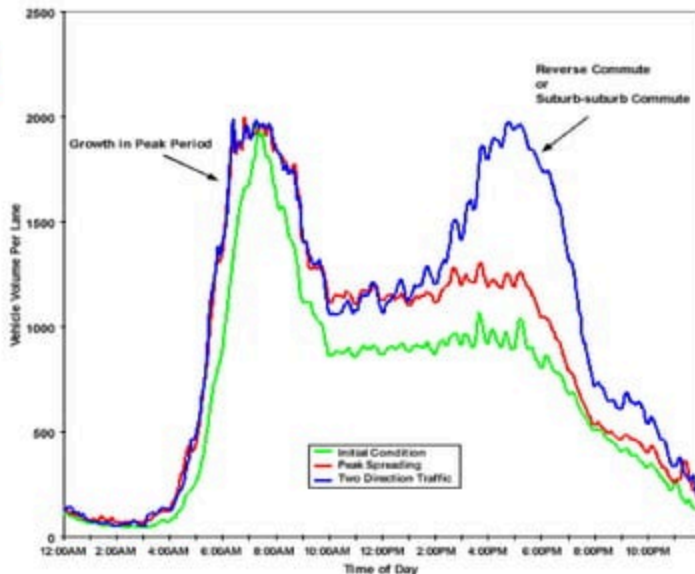

## Pavement surface characteristics

Pavement surface depend on the type of pavement which is decided based on the,

- Availability of material
- Volume and composition of traffic
- Soil subgrade
- Climatic condition
- Construction facility
- Cost consideration

The important surface characteristics are:

- Friction
- Pavement unevenness
- Light reflecting characteristics
- Drainage of surface water



## friction

- **Skidding:** when the path travelled along the road surface is more than the circumferential movement of the wheels due to their rotation.
- **Slipping:** when a wheel revolves more than the corresponding longitudinal movement along the road.

### Factors affecting the friction or skid resistance

- Types of pavement surface
- Roughness of pavement
- Condition of the pavement: wet or dry
- Type and condition of tyre
- Speed of the vehicle
- Brake efficiency
- Load and tyre pressure
- Temperature of tyre and pavement

❖ Smooth and worn out tyres offer higher friction factor on dry pavement but new tyre with good threads gives higher friction factor on wet pavement

❖ IRC recommended the longitudinal co-efficient of friction varies 0.35 to 0.4 and lateral co-efficient of friction of 0.15

### HYDROPLANING

(a layer of water between the tire and road)

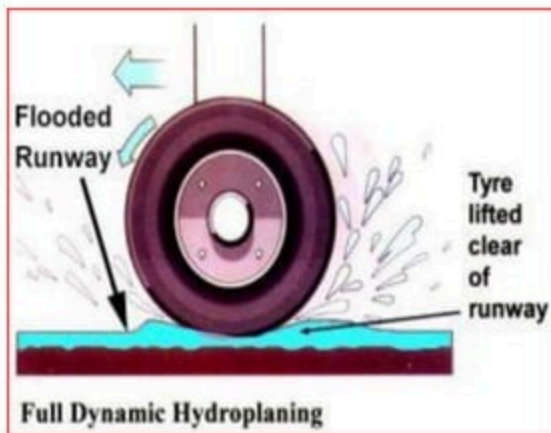

## Pavement unevenness

- Higher operating speed are possible on even surface than uneven surface.
- It affects,
  - Vehicle operation cost
  - Comfort and safety
  - Fuel consumption
  - Wear and tear of tyres and other moving parts
- It is commonly measure by an equipment call “**Bump Integrator**”
- **Bump integrator** is the cumulative measure of vertical undulations of the pavement surface recorded per unit horizontal length.
- 250 cm/km for a speed of 100kmph and more than 350 cm/km considered very unsatisfactory even at speed of 50 kmph.

## ❖ Unevenness of pavement surface may be caused by

- In adequate compaction of the fill, subgrade and pavement layers.
- Un-scientific construction practices including the use of boulder stones and bricks as soiling course over loose subgrade soil.
- Use of inferior pavement material.
- Improper surface and subsurface drainage.
- Improper construction machinery.
- Poor maintenance



## Light reflecting characteristics

- Night visibility very much depends upon the light reflecting characteristics of the pavement surface
- The glare caused by the reflection of head light is high on wet pavement surface than on dry pavement particularly in case of black top pavement or flexible pavement.
- Light colored or white pavement or rigid pavement surface give good visibility at night particularly during the rain, and produces glare or eye strain during bright sunlight.

## Highway cross section elements

- Carriageway
- Shoulder
- Roadway width
- Right of way
- Building line
- Control line
- Median
- Camber/ cross slope
- Crown
- Side slope
- Kerb
- Guard rail
- Side drain
- Other facilities

## Carriageway:

- It is the travel way which is used for movement of vehicle, it takes the vehicular loading .
- It may be cement concrete road or bituminous pavement.
- Width of carriageway is determined on the basis of the width of the vehicle and the minimum side clearance for safety.
- As per IRC specification, the maximum width of vehicle is 2.44m, minimum clearance of 0.68 in case of single lane and 1.02m in case of double lane.



### WIDTH OF CARRIAGEWAY

SL. NO.	Class of road	Width of carriageway in 'm'
1	Single lane	3.75
2	Two lane without raised kerbs	7.0
3	Two lane with raised kerbs	7.5
4	Intermediate lane	5.5
5	Multilane pavement	3.5/lane

### WIDTH OF ROADWAY OF VARIOUS CLASSES OF ROADS

SL. No.	Road classification	Roadway width	
		Plane and rolling terrain	Mountainous and steep terrain
1	NH & SH		
	a) Single lane	12	6.25
	b) two lane	12	6.25
2	MDR		
	a) Single lane	9	4.75
	b) two lane	9	4.75
3	ODR		
	a) Single lane	7.5	4.75
	b) two lane	9	4.75
4	Village roads-single lane	7.5	4

Two lane two-way road

carriageway



## Shoulder:

- It is provided along the road edge to serve as an emergency lane for vehicle.
- It act as a service lane for vehicles that have broken down.
- The minimum shoulder width of 4.6 m so that a truck stationed at the side of the shoulder would have a clearance of 1.85m from the pavement edge.
- IRC recommended the minimum shoulder width is 2.5 m
- It should have sufficient load bearing capacity even in wet weather.
- The surface of the should be rougher than the traffic lanes so that vehicles are discouraged to use the shoulder as a regular traffic.
- The colour should be different from that of the pavement so as to be distinct.



shoulder

Cycle track



Footpath

unTreated  
shoulder

Treated  
shoulder



## Width of the roadway or formation width:

- It is the sum of the width of the carriageway or pavement including separators if any and the shoulders.

## Right of way:

- It is the total area of land acquired for the road along its alignment.
- It depends on the importance of the road and possible future development.
- It is desirable to acquire more width of land as the cost of adjoining land invariably increases very much , soon after the new highway is constructed.

## Building lane:

- In order to reserve sufficient space for future development of roads, It is desirable to control the building activities on either side of the road boundary, beyond the land width acquired for the land.

## Control lines:

- In addition to “building line”, it is desirable to control the nature of building upto further “set back distance” .

## Traffic separators or median:

- The main function is to prevent head on collision between the vehicle moving in opposite direction.
- Channelize traffic into streams at intersection.
- Segregate slow traffic and to protect pedestrians.
- IRC recommends a minimum desirable width of 5 m and may be reduce to 3 m where land is restricted.
- The minimum width of median in urban area is 1.2m.



4-lane divided carriage way or dual carriage way

Median/  
separator



## Cross slope or camber:

- It is the slope provided to the road surface in the transverse direction to drain off the rain water from the road surface.
- To prevent the entry of surface water into the subgrade soil through pavement.
- To prevent the entry of water into the bituminous pavement layer.
- To remove the rain water from the pavement surface as quick as possible and to allow the pavement to get dry soon after the rain.
- It is expressed as a percentage or 1V:Nh.
- It depends on the pavement surface and amount of rainfall.

## Shape of the cross slope:

- Parabolic shape(fast moving vehicle)
- Straight line
- Combination of parabolic and straight line

**Recommended values of camber for different types of road surface**

Sl no.	Type of road surface	Range of camber in areas of rain fall range	
		heavy	light
1	Cement concrete and high type bituminous pavement	1 in 50(2%)	1 in 60(1.7%)
2	Thin bituminous surface	1 in 40(2.5%)	1 in 50(2%)
3	Water bound macadam(WBM) and gravel pavement	1 in 33(3%)	1 in 40(2.5%)
4	Earth	1 in 25(4%)	1 in 33(3%)

### EXAMPLE-1

In a district where the rainfall is heavy, major district road of WBM pavement, 3.8 m wide, and a state highway of bituminous concrete pavement, 7.0 m wide are to be constructed. What should be the height of the crown with respect to the edges in these two cases ?

## Too steep slope is not desirable because of the following reasons

- Uncomfortable side thrust and unequal wear of the tyres as well as road surface.
- Problem of toppling over highly laden bullock cart and truck.
- Tendency of most of vehicle travel along the centre line.

### Kerb:

- It indicates the boundary between the pavement and shoulder.
- It is desirable to provide kerbs in urban areas.
- It is of three types

#### 1-Low or mountable kerb:

- It allow the driver to enter the shoulder area with little difficulty.
- The height of the this type of shoulder kerb is about 10 cm above the pavement edge with slope to help the vehicle climb the kerb easily.

## 2-Semi-barrier kerb:

- It is provided on the periphery of a roadway where the pedestrian traffic is high.
- Height of about 15 cm above the pavement edge with a batter of 1:1 on the top 7.5 cm.
- It prevents parking the vehicle but during emergency it is possible to drive over this kerb with some difficulty.

## 3-Barrier type kerb:

- It is provided in built-up area adjacent to the foot paths with considerable pedestrian traffic.
- The height of the kerb is about 20 cm above the pavement edge with a steep batter of 1V:0.25H.



kerb



## Guard rail

- It is provided at the edge of the shoulder when the road is constructed on a fill exceeds 3 m.
- It is also provided on horizontal curve so as to provide a better night visibility of the curves under the head light of the vehicle.





**Guard rail**

# Road margins

## Parking lane:

- These are provided on urban roads to allow kerb parking
- As far as possible only parallel parking should be allowed as it is safer for moving vehicle.
- It should have sufficient width say 3m

## Lay bay:

- These are provided near the public conveniences with guide map to enable driver to stop clear off the carriageway.
- It has 3m width,30m length with 15m end tapers on both sides.

## Bus bays:

- These may be provided by recessing the kerb to avoid conflict with moving traffic.
- It is located atleast 75m away from the intersection.

## Frontage road:

- These are provided to give access to properties along an important highway with control access to express way or free way
- It may run parallel to the highway and are isolated by separator.

## Driveway:

- It connect the highway with commercial establishment like fuel stations, service stations etc...
- It should be located away from the intersection.

## Cycle track:

- It provided in urban areas when the volume of cycle traffic on the road is very high.
- A minimum width of 2m is provided for cycle track.

## Footpath:

- These are provided in urban areas when the vehicular as well as pedestrian traffic are heavy.
- To protect the pedestrian and decrease accident.
- Minimum width of 1.5m is provided.



## Mandatory Give-Way at Bus Bays

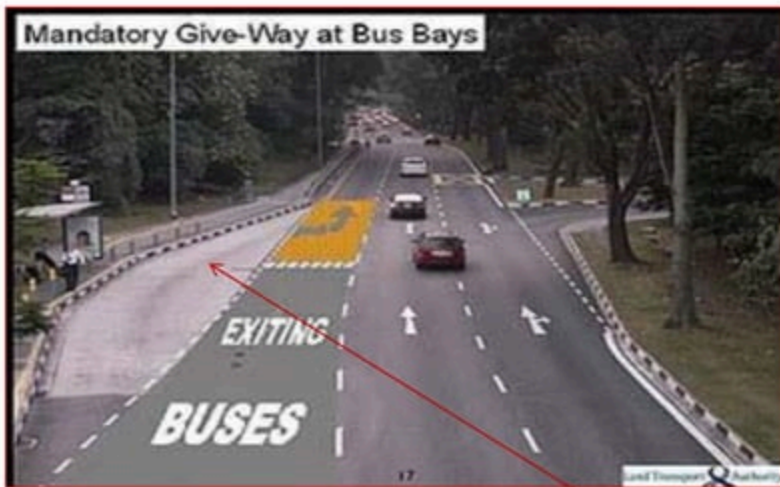

Bus  
bays



Frontage  
road

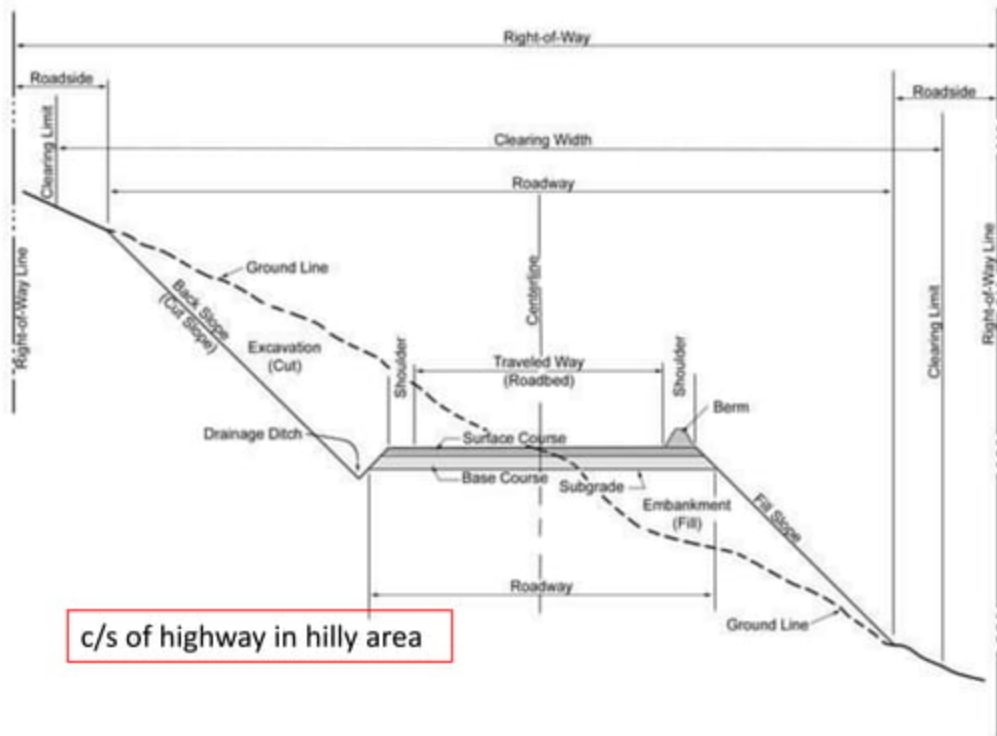

Typical Road Section

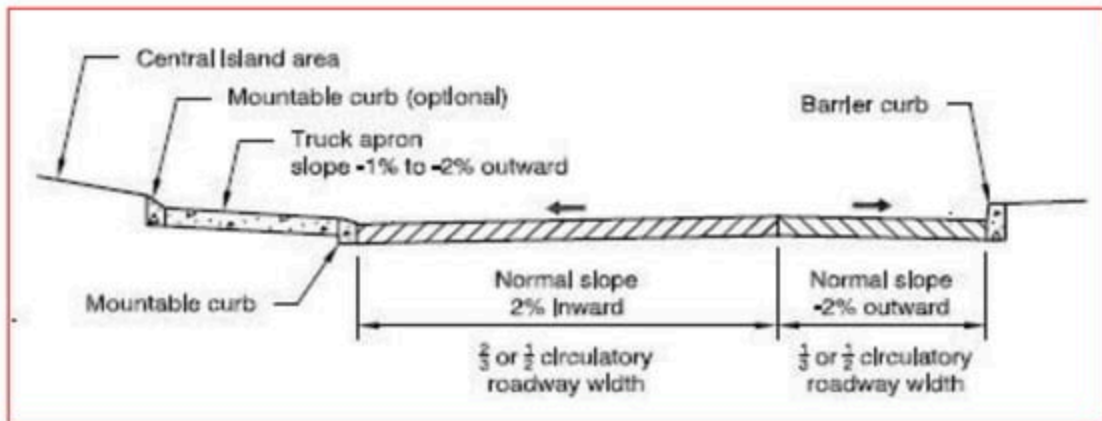

c/s of road in built-up area

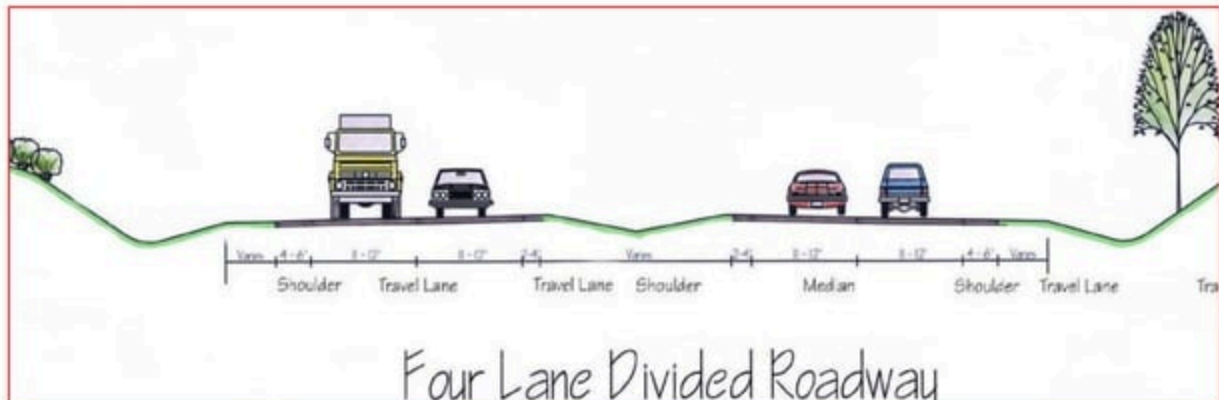



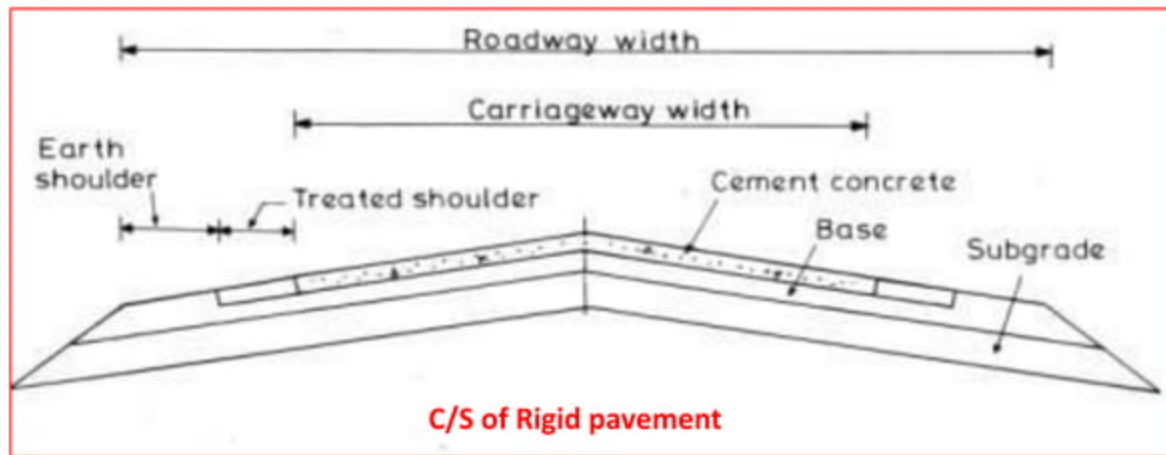
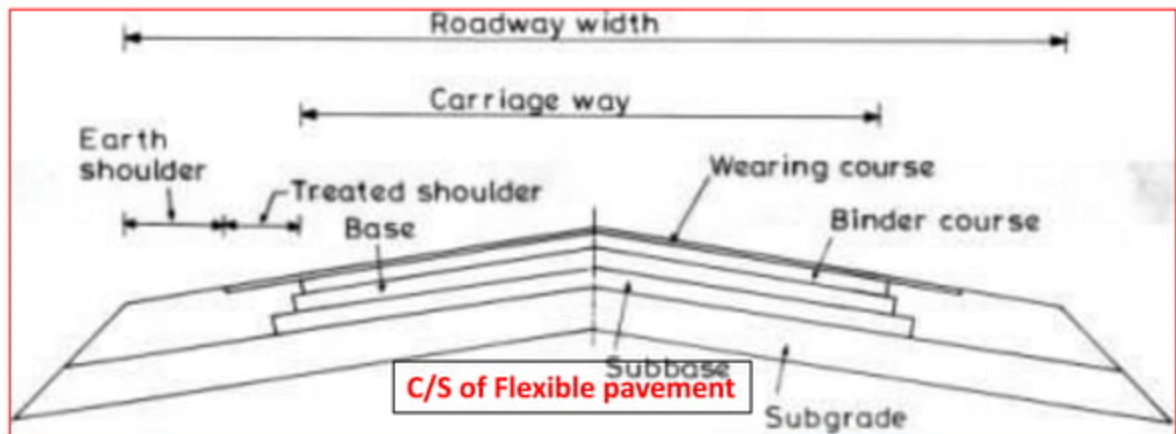



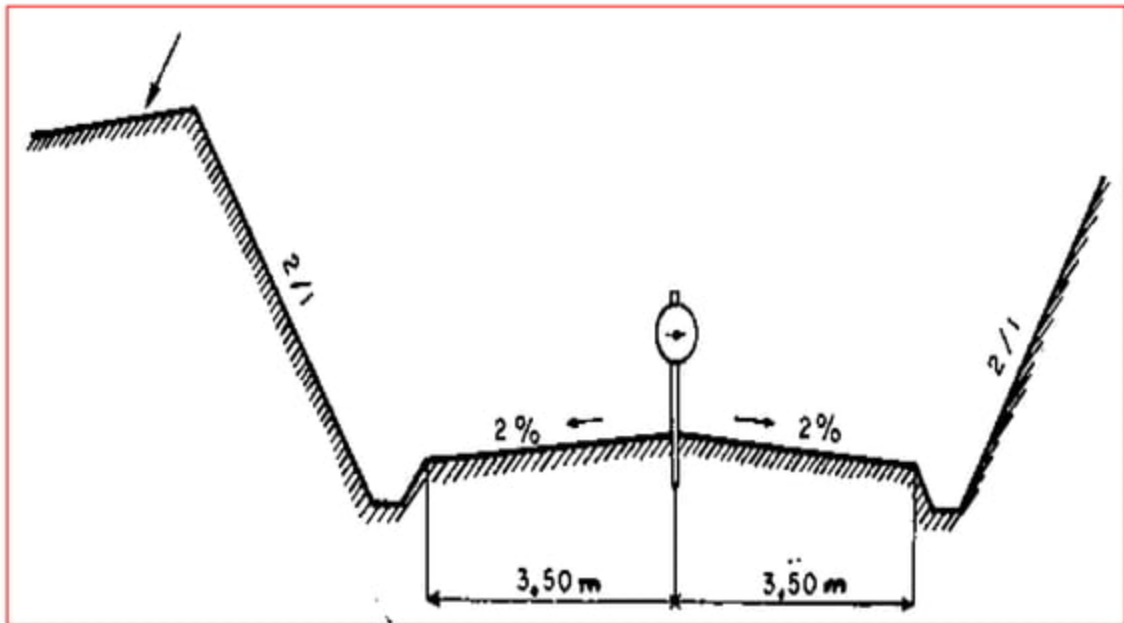

c/s of road in cutting

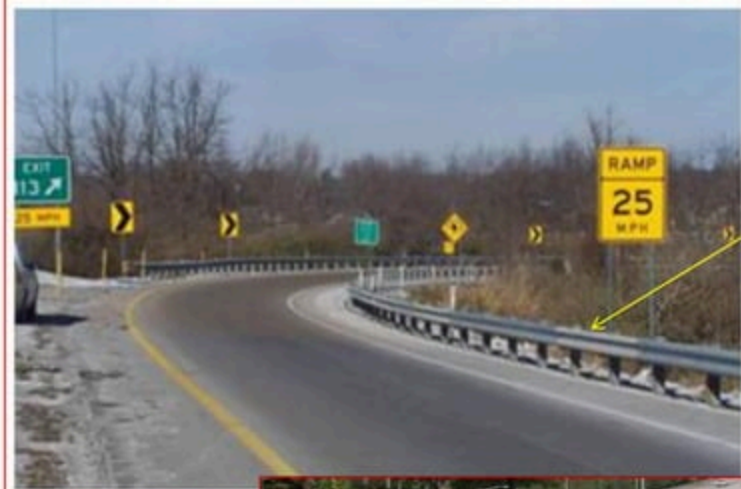

**Guard rails**



# Bibliography

- Khanna, S. K., & Justo, C. E. G. "*Highway engineering*". *Nem Chand & Bros.*
- *IRC Codes.*

# SIGHT DISTANCE

- Sight distance available from a point is the actual distance along the road surface, which a driver from a specified height above the carriageway has visibility of stationary or moving objects. OR
- It is the length of road visible ahead to the driver at any instance.

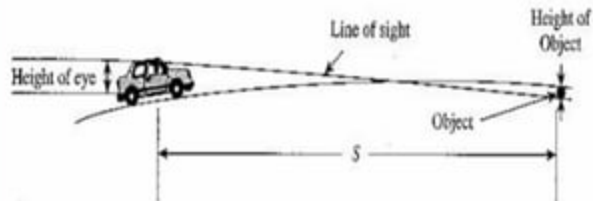

**FIGURE 4.8**  
Stopping sight distance diagram for crest vertical curve.

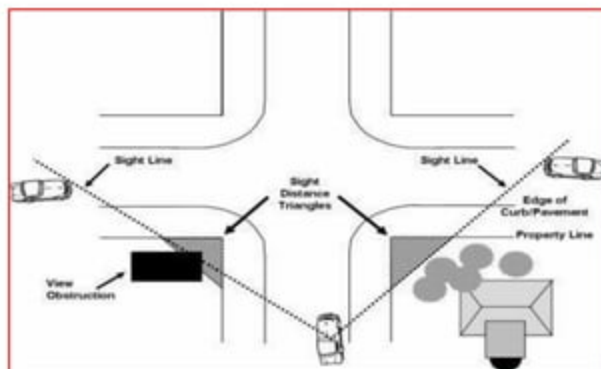

## Types of sight distance

- Stopping or absolute minimum sight distance(SSD)
- Safe overtaking or passing sight distance (OSD)
- Safe sight distance for entering into uncontrolled intersection.
- Intermediate sight distance
- Head light sight distance

## Stopping sight distance:

- The minimum sight distance available on a highway at any spot should be of sufficient length to stop a vehicle traveling at design speed, safely without collision with any other obstruction.

## Over taking sight distance:

- The minimum distance open to the vision of the driver of a vehicle intending to overtake slow vehicle ahead with safety against the traffic of opposite direction is known as the minimum overtaking sight distance (OSD) or the safe passing sight distance.

## Sight distance at intersection:

- Driver entering an uncontrolled intersection (particularly unsignalised Intersection) has sufficient visibility to enable him to take control of his vehicle and to avoid collision with another vehicle.



## Intermediate sight distance:

- This is defined as twice the stopping sight distance. When overtaking sight distance can not be provided, intermediate sight distance is provided to give limited overtaking opportunities to fast vehicles.

## Head light sight distance:

- This is the distance visible to a driver during night driving under the illumination of the vehicle head lights. This sight distance is critical at up-gradients and at the ascending stretch of the valley curves.

## Stopping Sight Distance

- SSD is the minimum sight distance available on a highway at any spot having sufficient length to enable the driver to stop a vehicle traveling at design speed, safely without collision with any other obstruction.

It depends on:

- Feature of road ahead
- Height of driver's eye above the road surface(1.2m)
- Height of the object above the road surface(0.15m)

## Criteria for measurement

- Height of driver's eye above road surface ( $H$ )
- Height of object above road surface ( $h$ )



### IRC

- $H = 1.2\text{m}$
- $h = 0.15\text{m}$

## Factors affecting the SSD

- Total reaction time of driver
- Speed of vehicle
- Efficiency of brakes
- Frictional resistance between road and tyre
- Gradient of road

## Total reaction time of driver:

- It is the time taken from the instant the object is visible to the driver to the instant the brake is effectively applied, it divide into types
  1. Perception time
  2. Brake reaction time

### Perception time:

- it is the time from the instant the object comes on the line of sight of the driver to the instant he realizes that the vehicle needs to be stopped.

### Brake reaction time:

- The brake reaction also depends on several factor including the skill of the driver, the type of the problems and various other environment factor.
- Total reaction time of driver can be calculated by “PIEV” theory

## “PIEV” Theory

Total reaction time of driver is split into four parts:

- P-perception
- I-intellection
- E-Emotion
- V-Volition

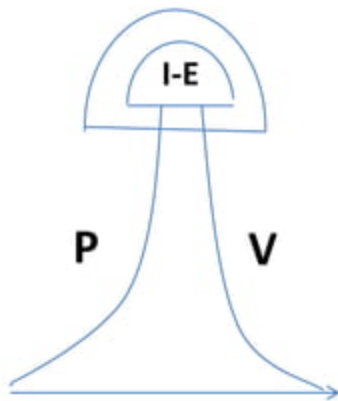

## perception

- It is the time required for the sensation received by the eyes or ears to be transmitted to the brain through the nervous system and spinal chord.

## Intellection:

- It is the time required for understanding the situation.

## Emotion:

- It is the time elapsed during emotional sensation and disturbance such as fear, anger or any other emotional feeling such as superstition etc, with reference to the situation.

## Volition:

- It is the time taken for the final action

Total reaction time of driver may be vary from 0.5 sec to 4 sec

## Analysis of SSD

- The stopping sight distance is the sum of lag distance and the braking distance.

### Lag distance:

- It is the distance, the vehicle traveled during the reaction time
- If 'V' is the design speed in m/sec and 't' is the total reaction time of the driver in seconds,

lag distance =  $v \cdot t$  metres.  
Where "v" in m/sec  
 $t = 2.5$  sec

Lag distance =  $0.278 V \cdot t$  meters  
Where "v" in Kmph,  
T = time in sec = 2.5 sec



## Braking distance :

- It is the distance traveled by the vehicle after the application of brake. For a level road this is obtained by equating the work done in stopping the vehicle and the kinetic energy of the vehicle.
- work done against friction force in stopping the vehicle is  $F \times l = f W l$ , where  $W$  is the total weight of the vehicle.
- The kinetic energy at the design speed of  $v$  m/sec will be  $\frac{1}{2} m. v^2$

$$\text{Braking distance} = v^2/2gf$$

SSD=lag distance + braking distance

$$\text{SSD} = 0.278V.t + v^2/254f$$

Table 2.6: Coefficient of longitudinal friction

Speed, kmph	30	40	50	60	>80
Longitudinal coefficient of friction	0.40	0.38	0.37	0.36	0.35

- Two-way traffic single lane road:  $SSD = 2 * SSD$
- In one-way traffic with single or more lane or two-way traffic with more than single lane: Minimum  $SSD = SSD$

### Example-1

- Calculate the safe stopping sight distance for design speed of 50kmph for (a) two-way traffic on two lane road (b) two-way traffic on single lane road

### Example-2

- Calculate the minimum sight distance required to avoid a head on collision of two cars approaching from opposite direction at 90 and 60kmph. coefficient friction of 0.7 and a brake efficiency of 50%, in either case

### Example-3

- Calculate the stopping sight distance on a highway at a descending gradient of 2% for design speed of 80 kmph, assume other data as per IRC specification.

## OVERTAKING SIGHT DISTANCE

- The minimum distance open to the vision of the driver of a vehicle intending to overtake slow vehicle ahead with safety against the traffic of opposite direction is known as the minimum overtaking sight distance (OSD) or the safe passing sight distance.
- The overtaking sight distance or OSD is the distance measured along the centre of the road which a driver with his eye level 1.2 m above the road surface can see the top of an object 1.2 m above the road surface.

## Factors affecting the OSD

- speeds of
  - overtaking vehicle
  - overtaken vehicle
  - the vehicle coming from opposite direction, if any.
- Distance between the overtaking and overtaken vehicles.
- Skill and reaction time of the driver
- Rate of acceleration of overtaking vehicle
- Gradient of the road

## Analysis of OSD

- Follow the Fig. 4.14, p-96 of highway engineering by S.K. Khanna and C.E.G. Justo
- $d_1$  is the distance traveled by overtaking vehicle "A" during the reaction time  $t$  sec of the driver from position  $A_1$  to  $A_2$ .
- $D_2$  is the distance traveled by the vehicle A from  $A_2$  to  $A_3$  during the actual overtaking operation, in time  $T$  sec.
- $D_3$  is the distance traveled by on-coming vehicle C from  $C_1$  to  $C_2$  during the over taking operation of A, i.e.  $T$  sec.
- B is the overtaken or slow moving vehicle.

## Cont...

- **B** is the overtaken or slow moving vehicle moving with uniform speed  $V_b$  m/sec or  $V_b$  Kmph;
- **C** is a vehicle coming from opposite direction at the design speed  $V$  m/sec or  $V$  kmph
- The distance traveled by the vehicle A during this reaction time is **d1** and is between the positions A1 and A2. this distance will be equal to  $V_b \cdot t$  meter
- where  $t$  is the reaction time of the driver in second= 2 sec.

$$\text{OSD} = d_1 + d_2 + d_3$$

$$\text{OSD} = 0.28 V_b \cdot t + 0.28 V_b \cdot T + 2s + 0.28 V \cdot T$$

$$S = \text{SPACING OF VEHICLES} = (0.2 V + 6)$$

$$T = \sqrt{4 \times 3.6s} / A = \sqrt{14.4s} / A$$

If the speed of the overtaken vehicle is not given

$V_b = (V - 16)$  kmph, where  $V$  = speed of overtaking vehicle in kmph

- The minimum overtaking sight distance =  $d_1 + d_2 + d_3$  for two-way traffic.
- On divide highways and on roads with one way traffic regulation, the overtaking distance =  $d_1 + d_2$  as no vehicle is expected from the opposite direction.



## Overtaking Zones

- It is desirable to construct highways in such a way that the length of road visible ahead at every point is sufficient for safe overtaking. This is seldom practicable and there may be stretches where the safe overtaking distance can not be provided. But the overtaking opportunity for vehicles moving at design speed should be given at frequent intervals. These zones which are meant for overtaking are called overtaking zones.
- The minimum length of overtaking zone should be three times the safe overtaking distance i.e.,  $3(d_1+d_2)$  for one-way roads and  $3(d_1+d_2+d_3)$  for two-way roads.
- Desirable length of overtaking zones is kept five times the overtaking sight distance. i.e.,  $5(d_1+d_2)$  for one-way roads and  $5(d_1+d_2+d_3)$  for two-way roads.

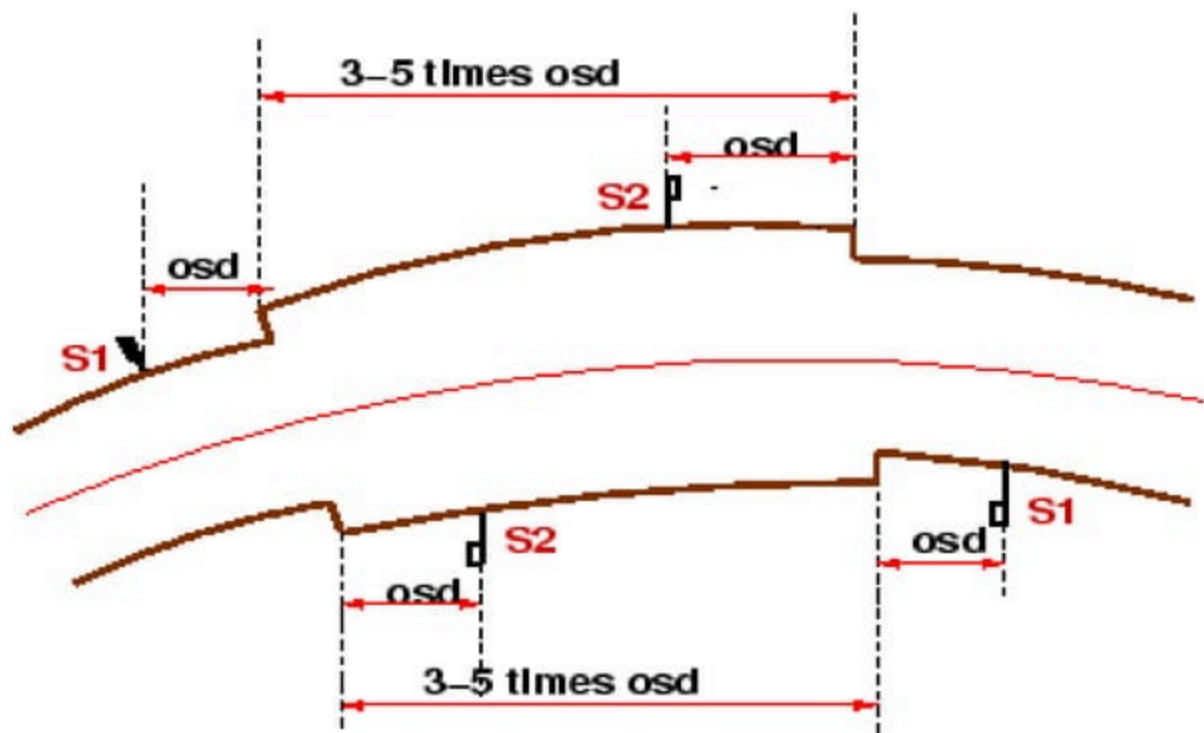

**S1— Overtaking zone begin**  
**S2— End of Overtaking zone**

## Example-1

The speed of the overtaking and overtaken vehicle are 70 and 40 kmph, respectively on a two way traffic road. If the acceleration of overtaking vehicle is  $0.99 \text{ m/sec}^2$ ,

- Calculate safe overtaking sight distance
- Calculate the minimum and desirable length of overtaking zone
- Draw the neat-sketch of the overtaking zone and show the position of the sign post.

## Example-2

Calculate the safe overtaking sight distance for a design speed of 96 kmph, assume all other data suitable

# **DESIGN OF HORIZONTAL ALIGNMENT**



Photo: Dan Nabors, VHB



**Horizontal  
curve**

## Horizontal Curves

- A horizontal highway curve is a curve in plan to provide change in direction to the central line of a road. When a vehicle traverses a horizontal curve, the centrifugal force acts horizontally outwards through the centre of gravity of the vehicle.
- $P = W v^2/gR$
- Where,
  - $P$  = centrifuge force, kg
  - $W$  = weight of the vehicle, kg
  - $R$  = radius of the circular curve, m
  - $v$  = speed of vehicle, m/sec
  - $g$  = acceleration due to gravity = 9.8 m/sec

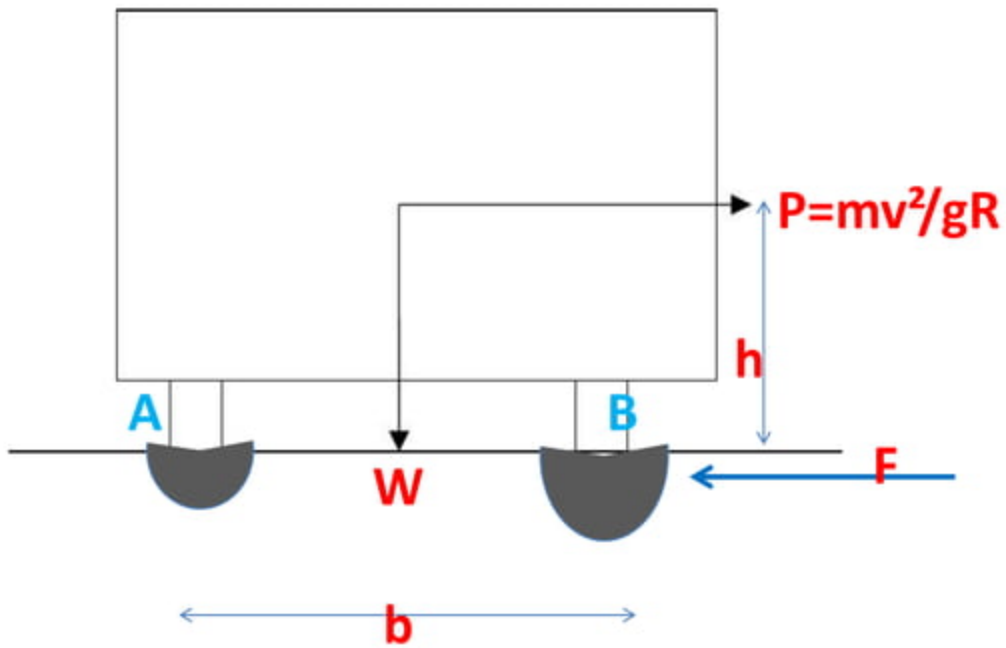

## Cont.....

- $P/W$  is known as the centrifugal ratio or the impact factor. The centrifuge ratio is thus equal to  $v^2/gR$
- The centrifugal force acting on a vehicle negotiating a horizontal curve has two effects
  - Tendency to overturn the vehicle outwards about the outer wheels
  - Tendency to skid the vehicle laterally, outwards

### Overturning effect

- The equilibrium condition for overturning will occur when  $Ph = Wb/2$ , or when  $P/W = b/2h$ . This means that there is danger of overturning when the centrifugal when the centrifugal ratio  $P/W$  or  $v^2/gR$  attains a values of  $b/2h$ .



## Transverse skidding effect

- $P = F_A + F_B = f(R_A + R_B) = fW$
- Since  $P = fW$ , the centrifugal ratio  $P/W$  is equal to ' $f$ '. In other words when the centrifugal ratio attains a value equal to the coefficient of lateral friction there is a danger of lateral skidding.
- Thus to avoid overturning and lateral skidding on a horizontal curve, the centrifugal ratio should always be less than  $b/2h$  and also ' $f$ '
- ' $f$ ' is less than  $b/2h$ . - The vehicle would skid and not overturn
- $b/2h$  is lower than ' $f$ ' - The vehicle would overturn on the outer side before skidding

## Superelevation

- In order to counteract the effect of centrifugal force and to reduce the tendency of the vehicle to overturn or skid, the outer edge of the pavement is raised with respect to the inner edge, thus providing a transverse slope throughout the length of the horizontal curve, this transverse inclination to the pavement surface is known as **Superelevation** or **cant** or **banking**.
- The Superelevation 'e' is expressed as the ratio of the height of outer edge with respect to the horizontal width.

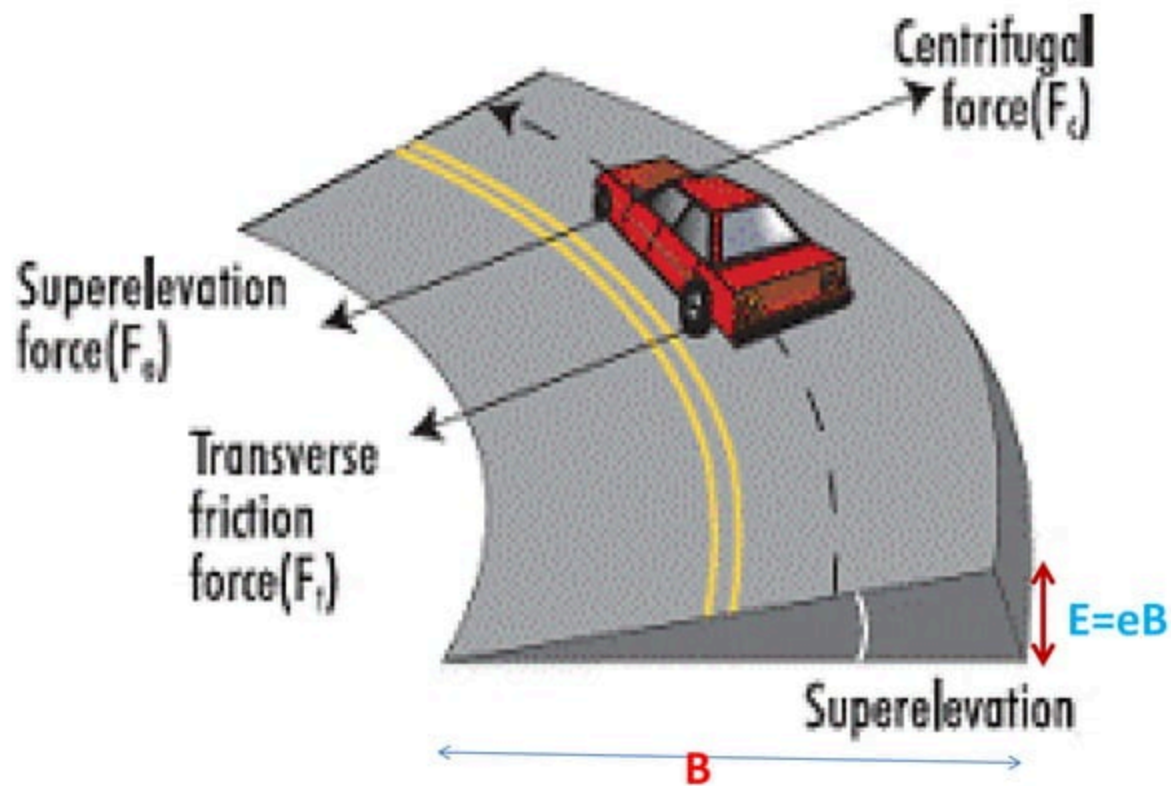

# Superelevation

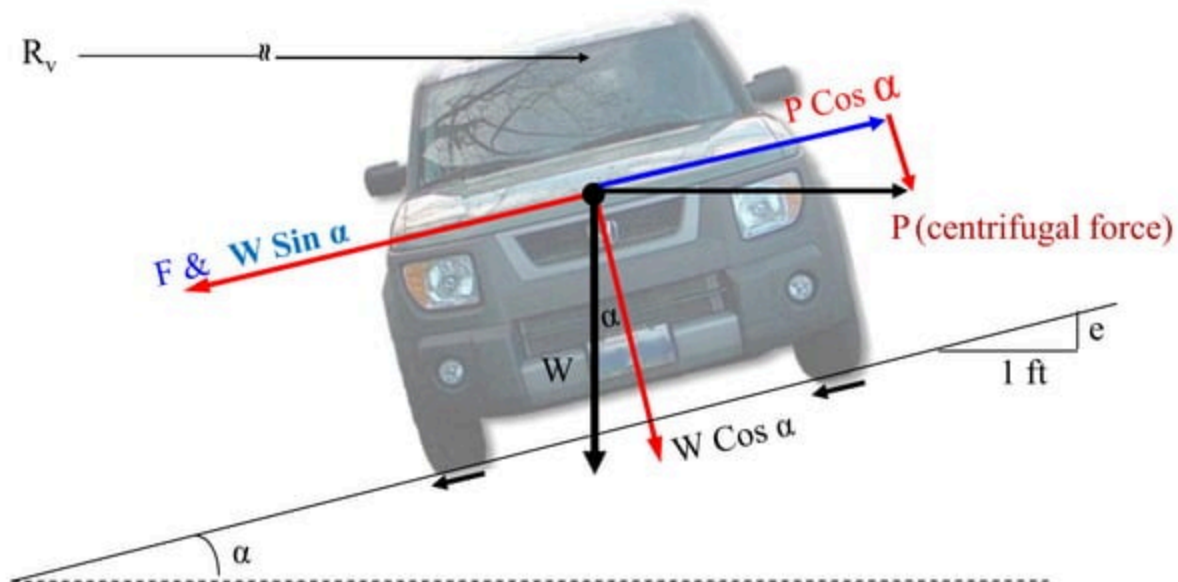

$$W \sin \alpha + f \left( W \cos \alpha + \frac{WV^2}{gR} \sin \alpha \right) = \frac{WV^2}{gR} \cos \alpha$$

## Analysis of Superelevation

- The force acting on the vehicle while moving on a circular curve of radius  $R$  meters, at speed of  $v$  m/sec are
- The centrifugal force  $P = Wv^2/gR$  acting horizontal outwards through the centre of gravity, CG
- The weight  $W$  of the vehicle acting vertically downwards through the CG
- The frictional force developed between the wheels and the pavement counteractions transversely along the pavement surface towards the centre of the curve

## Superelevation cont...

$$W \sin \alpha + f \left( W \cos \alpha + \frac{WV^2}{gR} \sin \alpha \right) = \frac{WV^2}{gR} \cos \alpha$$

**OR**  $\tan \alpha + f = \frac{V^2}{gR} (1 - f \tan \alpha)$  Dividing Cos  $\alpha$  on both sides

**OR**  $e + f = \frac{V^2}{gR} (1 - fe)$  (1-fe)=1-0.15x.07=0.99≈ 1

**OR**  $R = \frac{V^2}{g(f + e)}$

**OR**  $e + f = \frac{V^2}{gR}$

V in m/Sec  
R in 'm'

**OR**  $e + f = \frac{V^2}{127R}$

V in kmph  
R in 'm'

## Cont...

- $e$  = rate of Superelevation =  $\tan \theta$
- $f$  = design value of lateral friction coefficient = 0.15
- $v$  = speed of the vehicle, m/sec
- $R$  = radius of the horizontal curve,  $g$  = acceleration due to gravity =  $9.8 \text{ m/sec}^2$

## Maximum Superelevation

- In the case of heavily loaded bullock carts and trucks carrying less dense materials like straw or cotton, the centre of gravity of the loaded vehicle will be relatively high and it will not be safe for such vehicles to move on a road with a high rate of Superelevation. Because of the slow speed, the centrifugal force will be negligibly small in the case of bullock carts. Hence to avoid the danger of toppling of such loaded slow moving vehicles, it is essential to limit the value of maximum allowable Superelevation.
- Indian Roads Congress had fixed the maximum limit of Superelevation in **plan and rolling terrains** and in snow bound areas as **7.0 %**.
- On **hill roads** not bound by snow a maximum Superelevation upto **10%** .
- On **urban road** stretches with frequent intersections, it may be necessary to limit the maximum Superelevation to **4.0 %**.



## Minimum Superelevation

- From drainage consideration it is necessary to have a minimum cross to drain off the surface water. If the calculated Superelevation is equal to or less than the camber of the road surface, then the minimum Superelevation to be provided on horizontal curve may be limited to the camber of the surface.

# Design of Superelevation

- **Step-1:** The Superelevation for 75 percent of design speed ( $v$  m/sec/kmph) is calculated neglecting the friction.

$$e = \frac{(0.75V)^2}{127R}$$

$$e = \frac{V^2}{225R}$$

- **Step-2:** If the calculated value of 'e' is less than 7% or 0.07 the value so obtained is provided. If the value of 'e' as step-1 exceeds 0.07 then provides maximum Superelevation equal to 0.07 and proceed with step-3 or 4.
- **Step-3:** Check the coefficient of friction of friction developed for the maximum value of  $e = 0.07$  at the full value of design speed.

$$f = \frac{V^2}{127R} - 0.07$$

- If the value of  $f$  thus calculated is less than 0.15 the Superelevation of 0.07 is safe for the design speed. If not, calculate the restricted speed as given in step -4.

## Cont....

- Step-4 The allowable speed ( $V_a$  m/sec. or  $V_a$  Kmph) at The curve is calculated by considering the design coefficient of lateral friction and the maximum Superelevation.
- $e+f=0.07+0.15=v_a^2/127R$
- If the allowed speed, as calculated above is higher than the design speed, then the design is adequate and provides a Superelevation of 'e' equal to 0.07.
- If the allowable speed is less than the design speed, the speed is limited to the allowed speed  $V_a$  kmph calculated above and Appropriate warning sign and speed limit regulation sign are installed to restrict and regulate the speed.

## Attainment of superelevation

Split-up into **two parts**::

- Elimination of crown of the cambered section
- Rotation of pavement to attain full superelevation

### Elimination of crown of the cambered section

**1<sup>st</sup> Method:** Outer edge rotated about the crown

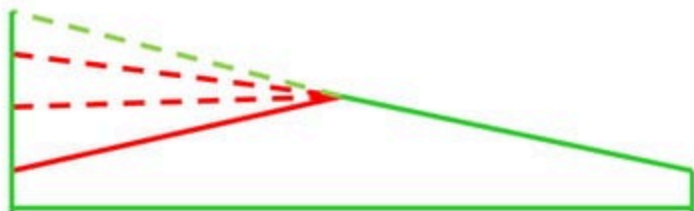

## Attainment of superelevation

### Disadvantages

- Small length of road – cross slope less than camber
- Drainage problem in outer half

## 2<sup>nd</sup> Method: Crown shifted outwards

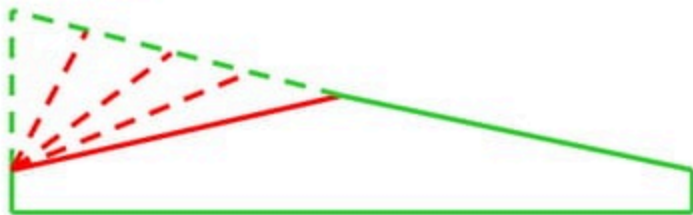

### Disadvantages

- Large negative superelevation on outer half
- Drivers have the tendency to run the vehicle along shifted crown

# Attainment of superelevation

## Rotation of pavement to attain full superelevation

1<sup>st</sup> Method: Rotation about the C/L (depressing the inner edge and raising the outer edge each by half the total amount of superelevation)

### Advantages

- Earthwork is balanced
- Vertical profile of the C/L remains unchanged

### Disadvantages

- Drainage problem: depressing the inner edge below the general level



## Attainment of superelevation

**2<sup>nd</sup> Method:** Rotation about the Inner edge (raising both the centre as well as outer edge – outer edge is raised by the total amount of superelevation)

### Advantages

- No drainage problem

### Disadvantages

- Additional earth filling
- C/L of the pavement is also raised (vertical alignment of the road is changed)

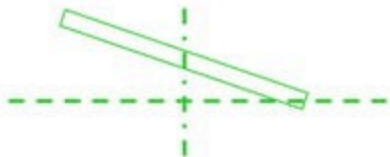

### Example-1

- The radius of horizontal circular curve is 100m. The design speed is 50kmph and the design coefficient of lateral friction is 0.15.
  - Calculate the superelevation required if full lateral friction is assumed to develop
  - Calculate the coefficient of friction needed if no superelevation is provided.
  - Calculate the equilibrium superelevation if the pressure on inner and outer wheels should be equal.

### Example-2:

- A two lane road with design speed 80kmph has horizontal curve of radius 480m. Design the rate of superelevation for mixed traffic. By how much should the outer edges of the pavement be raised with respect to the centre line , if the pavement is rotated with respect to the centre line.



### Exapmle-3:

- Design the super elevation for a horizontal highway curve of radius 500m and speed 100kmph

### Example-4

- The design speed of highway is 80kmph. There is horizontal curve of radius 200m on a certain locality. Calculate the superelevation needed to maintain this speed.

## Radius of Horizontal Curve

- The ruling minimum radius of the curve for ruling design speed  $v$  m/sec. or  $V$  kmph is given by.

$$R_{Ruling} = \frac{V^2}{127(e+f)}$$

- According to the earlier specifications of the IRC, the ruling minimum radius of the horizontal curve was calculated from a speed value, 16 kmph higher than the design speed i.e.,  $(V+16)$  kmph.

## Example-1

- Calculate the values of ruling minimum and absolute minimum radius of horizontal curve of a national highway in plane terrain. Assume ruling design speed and minimum design speed values as 100 and 80 kmph respectively.

## Widening of Pavement on Horizontal Curves

- On horizontal curves, especially when they are not of very large radii, it is common to widen the pavement slightly more than the normal width,
- Widening is needed for the following reasons :
  - ✓ The driver experience difficulties in steering around the curve.
  - ✓ The vehicle occupies a greater width as the rear wheel don't track the front wheel. known as 'Off tracking'
  - ✓ For greater visibility at curve, the driver have tendency not to follow the central path of the lane, but to use the outer side at the beginning of the curve.
  - ✓ While two vehicle cross or overtake at horizontal curve there is psychological tendency to maintain a greater clearance between the vehicle for safety.

## Off tracking

- An automobile has a rigid wheel base and only the front wheels can be turned, when this vehicle takes a turn to negotiate a horizontal curve, the rear wheel do not follow the same path as that of the front wheels. This phenomenon is called **off tracking**.
- The required extra widening of the pavement at the horizontal curves depends on the length of the wheel base of the vehicle ' $l$ ', radius of the curve ' $R$ ' and the psychological factors.

## Analysis of extra widening on curves

- It is divided into two parts;
  - ✓ Mechanical widening ( $W_m$ ): the widening required to account for the off tracking due to the rigidity of wheel base is called mechanical widening
  - ✓ Psychological widening ( $W_{ps}$ ): extra width of the pavement is also provided for psychological reasons such as , to provide for greater maneuverability of steering at high speed, to allow for the extra space for overhangs of vehicles and to provide greater clearance for crossing and overturning vehicles on curve.
- Total widening  $W = W_{ps} + W_m$

## Mechanical Widening

$$W_m = R_2 - R_1$$

From  $\Delta OAB$ ,

$$OA^2 = OB^2 - BA^2$$

$$R_1^2 = R_2^2 - l^2$$

$$(R_2 - W_m)^2 = R_2^2 - l^2$$

$$l^2 = W_m (2 R_2 - W_m)$$

$$W_m = l^2 / (2 R_2 - W_m)$$

$$W_m = l^2 / 2 R \text{ (Approx.)}$$

$$\text{or } W_m = nl^2 / 2R$$

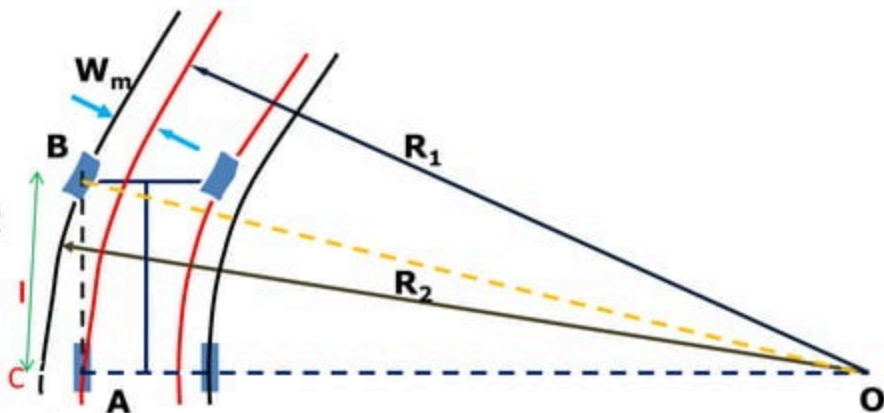

Where,  $R$  = Mean radius of the curve in m,

$n$  = no. of traffic lanes

$R$  = Mean radius of the curve, m

$l$  = Length of Wheel base of longest vehicle , m

(  $l$  = 6.0 m or 6.1m for commercial vehicles)

$V$  = design speed, kmph

---





## Psychological Widening

$$W_{Ps} = \frac{V}{9.5\sqrt{R}} \quad (\text{Empirical formula})$$

V = Design speed of the vehicle, km/h

R = Radius of the curve, m

Total extra widening = Mechanical widening  
+ Psychological Widening

$$W_e = \frac{nl^2}{2R} + \frac{V}{9.5\sqrt{R}}$$

## Method of introducing extra widening

- With transition curve: increase the width at an approximately uniform rate along the transition curve - the extra width should be continued over the full length of circular curve
- Without transition curves: provide two-third widening on tangent and the remaining one-third on the circular curve beyond the tangent point
- With transition curve: Widening is generally applied equally on both sides of the carriageway
- Without transition curve: the entire widening should be done on inner side
- On sharp curves of hill roads: the entire widening should be done on inner side

## Method of introducing extra widening

Follow Fig- 4.27, p-123

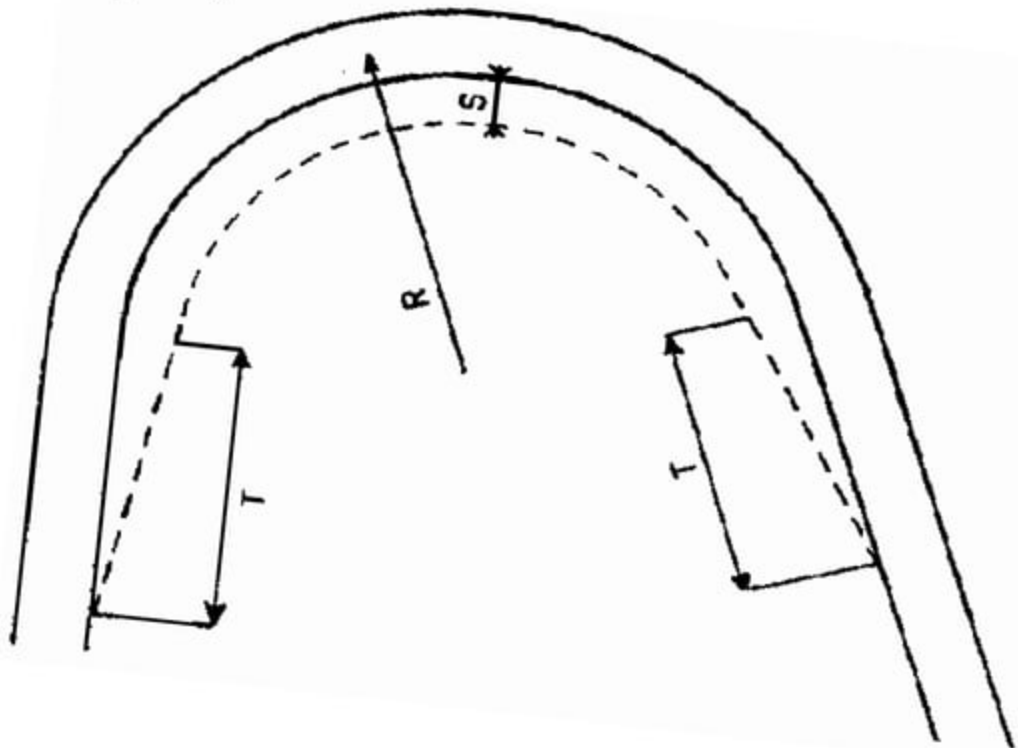



## Example-1

- Calculate the extra widening required for a pavement of width 7m on a horizontal curve of radius 250m if the longest wheel base of vehicle expected on the road is 7.0 m. design speed is 70 kmph.

## Example-2

- Find the total width of two lane road on a horizontal curve for a new National highway to be aligned along a rolling terrain with a ruling minimum radius having ruling design speed of 80 kmph. Assume necessary data as per IRC

## Horizontal transition curves

- When a non circular curve is introduced between a straight and a circular curve has a varying radius which decreases from infinity at the straight end (tangent point) to the desired radius of the circular curve at the other end (curve point) for the gradual introduction of centrifugal force is known as transition curve.

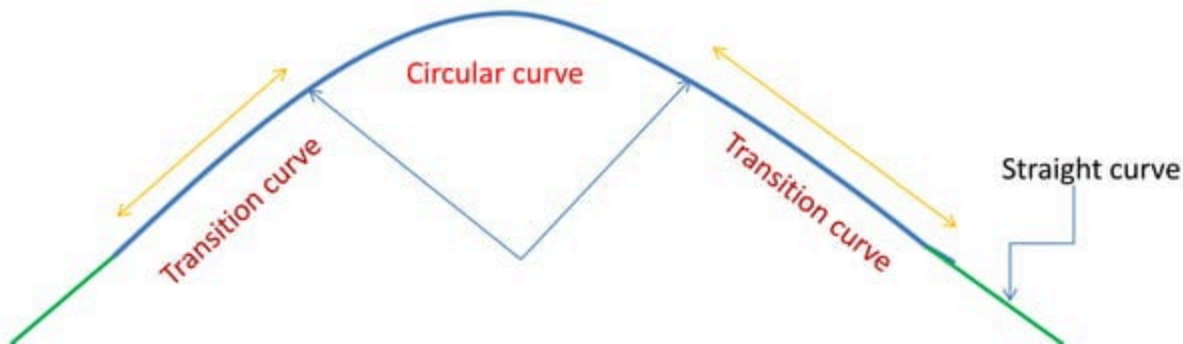

## Objectives for providing transition curve

- ✓ To introduce gradually the centrifugal force between the tangent point and the beginning of the circular curve, avoiding sudden jerk on the vehicle. This increases the comfort of passengers.
- ✓ To enable the driver turn the steering gradually for his own comfort and security
- ✓ To provide gradual introduction of super elevation
- ✓ To provide gradual introduction of extra widening.
- ✓ To enhance the aesthetic appearance of the road.

## Type of transition curve

- spiral or clothoid
- cubic parabola
- Lemniscate

} Follow the Fig-4.29, p-126 of highway Engineering by S.K. Khanna and C.E.G. Justo

- IRC recommends **spiral** as the transition curve because it fulfills the requirement of an ideal transition curve, that is;
  - ✓ rate of change or centrifugal acceleration is consistent
  - ✓ Radius of the transition curve is infinity at the straight edge and changes to  $R$  at the curve point ( $L_s \propto 1/R$ ) and calculation and field implementation is very easy.



## Length of transition curve

- Case-1: Rate of change of centrifugal acceleration

$$L_s = \frac{0.0215V^3}{CR}$$

$$C = \frac{80}{(75 + V)}$$

$$0.5 < C < 0.8$$

- Where,
  - ✓  $L_s$  = length of transition curve in 'm'
  - ✓  $C$  = allowable rate of change of centrifugal acceleration,  $m/sec^2$
  - ✓  $R$  = Radius of the circular curve in 'm'

## case-2: Rate of introduction of super-elevation

- If the pavement is rotated about the center line.

$$L_s = EN/2 = eN/2(W + W_e)$$

- If the pavement is rotated about the inner edge

$$L_s = EN = eN(W + W_e)$$

- Where  $W$  is the width of pavement
- $W_e$  is the extra widening
- Rate of change of superelevation of 1 in  $N$

### case-3: By empirical formula

- According to IRC standards:
  - ✓ For plane and rolling terrain:

$$L_S = \frac{2.7V^2}{R}$$

- ✓ For mountainous and steep terrain:

$$L_S = \frac{V^2}{R}$$

**The design length of transition curve( $L_s$ ) will be the highest value of case-1,2 and 3**



## Example-1

- Calculate the length of the transition curve and shift using the following data;
  - ✓ Design speed= 65 kmph
  - ✓ Radius of circular curve= 220 m
  - ✓ Allowable rate of superelevation= 1 in 150
  - ✓ Pavement rotated about the centre line of the pavement
  - ✓ Pavement width including extra widening= 7.5 m

## Example-2

- A national highway passing through rolling terrain in heavy rain fall area has a horizontal curve of radius 500 m. Design the length of transition curve using the following data.
  - ✓ Design speed of vehicle= 80 kmph
  - ✓ Allowable rate of superelevation= 1 in 150
  - ✓ Pavement rotated about the inner edge of the pavement.
  - ✓ Pavement width excluding extra widening= 7 m.

## Set-back distance on horizontal curve

Where there are sight obstruction like buildings, cut slope or trees on the inner sides of the curves, either the obstruction should be removed or the alignment should be changed in order to provide adequate sight distance. If it is not possible to provide adequate sight distance on the curves on existing roads, regulatory sign should be installed to control the traffic suitably.

clearance distance or set-back distance is the distance required from the centre line of a horizontal curve to an obstruct on the inner side of the of the curve to provide adequate sight distance

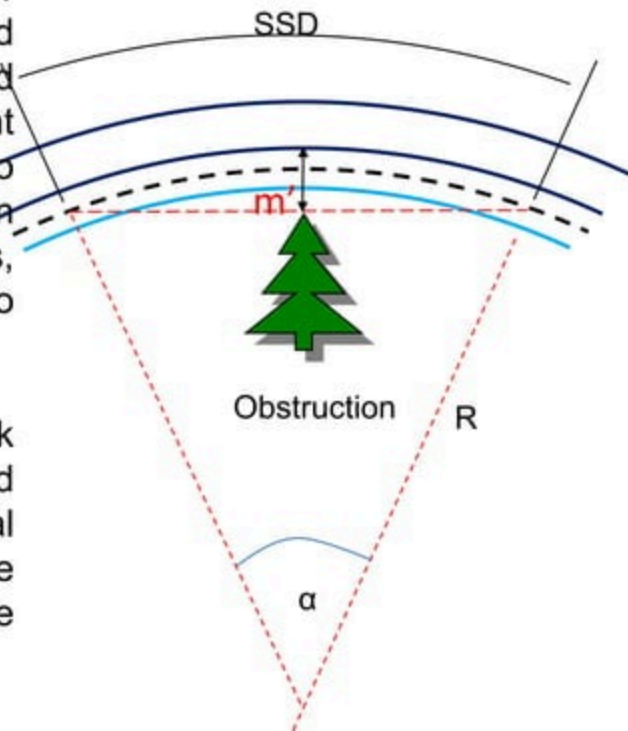

Case-I: if length of curve ( $L_c$ ) > sight distance( $S$ )

$$m' = R - (R - d) \cos \frac{\alpha'}{2}$$

$$\frac{\alpha'}{2} = \frac{180S}{2\pi(R - d)}$$

Where,

$M'$  = set-back distance

$d$  = the distance between the centre line of the road and the centre line of the inside lane in 'm'

$R$  = radius of the curve in 'm'

$\alpha$  = angle subtended by the arc length 'S' at the centre

Case-II: if length of curve ( $L_c$ ) < sight distance( $S$ )

$$m' = R - (R - d) \cos \frac{\alpha'}{2} + \frac{S - L_c}{2} \sin \frac{\alpha'}{2}$$

$$\frac{\alpha'}{2} = \frac{180 L_c}{2\pi(R - d)}$$

Where ' $L_c$ ' is the length of curve and ' $S$ ' is the sight distance



### Example-1:

- There is a horizontal curve of radius 400 m and length 200 m on this highway. Compute the set-back distance required from the centre line on the inner side of the curve so as to provide for
  - ✓ Stopping sight distance of 90 m
  - ✓ Safe overtaking distance of 300 m
  - ✓ Distance between the centre line of the road and the inner lane is 1.9 m.

### Example-2:

- A state highway passing through a rolling terrain has a horizontal curve of radius equal to the ruling minimum radius for a ruling design speed of 80 kmph. calculate the set-back distance required from the centre line on the inner side of the curve so as to provide for minimum SSD and ISD.

## Curve resistance

The automobiles are steered by turning the front wheels, but the rear wheels do not turn. When a vehicle driven by rear wheels move on a horizontal curve, the direction of rotation of rear and front wheels are different and so there is some losses in the tractive force.

thus the loss of tractive force due to turning of a vehicle on a horizontal curve, which is termed as **curve resistance** will be equal to  $(T - T \cos \alpha)$  or  $T (1 - \cos \alpha)$  and will depend on turning angle  $\alpha$

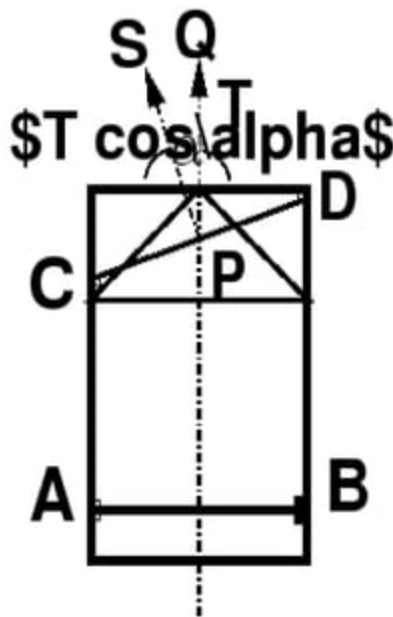

# Bibliography

- Khanna, S. K., & Justo, C. E. G. *“Highway engineering”*. Nem Chand & Bros.
- *IRC Codes*.

# Vertical alignment



The vertical alignment is the elevation or profile of the centre line of the road.

The vertical alignment consist of grade and vertical curve and it influence the vehicle speed, acceleration, sight distance and comfort in vehicle movements at high speed.

# Gradient

- It is the rate of rise or fall along the length of the road with respect to the horizontal. It is expressed as a ratio of **1 in x** (1 vertical unit to x horizontal unit). Some times the gradient is also expressed as a percentage i.e. **n%** (n in 100).
- Represented by:**

+n %

+ 1 in X (+ve or Ascending)

or -n%

- 1 in X (-ve or descending)

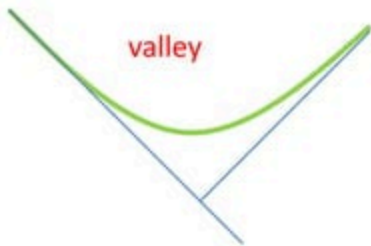
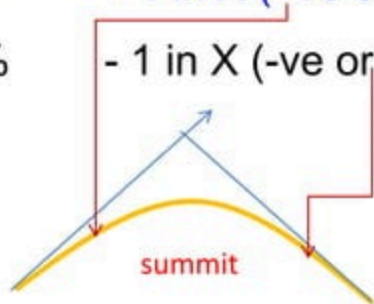

# Typical Gradients (IRC)

- Ruling Gradient
- Limiting Gradient
- Exceptional gradient
- Minimum Gradient
- Ruling gradient (design gradient):
- It is the maximum gradient within which the designer attempts to design the vertical profile of road, it depends on
  - Type of terrain
  - Length of grade
  - Speed
  - Pulling power of vehicles
  - Presence of horizontal curves
  - Mixed traffic

## Limiting Gradient:

- Steeper than ruling gradient. In hilly roads, it may be frequently necessary to exceed ruling gradient and adopt limiting gradient, it depends on
  - Topography
  - Cost in constructing the road

## Exceptional Gradient:

- Exceptional gradient are very steeper gradients given at unavoidable situations. They should be limited for short stretches not exceeding about 100 m at a stretch.

## critical length of the grade:

- The maximum length of the ascending gradient which a loaded truck can operate without undue reduction in speed is called critical length of the grade. A speed of 25 kmph is a reasonable value. This value depends on the size, power, load, initial speed.

## Minimum gradient

- This is important only at locations where surface drainage is important. Camber will take care of the lateral drainage. But the longitudinal drainage along the side drains require some slope for smooth flow of water. Therefore minimum gradient is provided for drainage purpose and it depends on the rain fall, type of soil and other site conditions.
- A minimum of 1 in 500 may be sufficient for concrete drain and 1 in 200 for open soil drains.



## Value of gradient as per IRC

<b>Terrain</b>	<b>Ruling gradient</b>	<b>Limiting gradient</b>	<b>Exceptional gradient</b>
<b>Plain and Rolling</b>	<b>3.3% (1 in 30)</b>	<b>5%</b>	<b>6.70%</b>
<b>Mountainous terrain</b>	<b>5% (1 in 20)</b>	<b>6%</b>	<b>7%</b>
<b>Steep terrain up to 3000m (MSL)</b>	<b>5% (1 in 20)</b>	<b>6%</b>	<b>7%</b>
<b>Steep terrain ( &gt;3000m)</b>	<b>6% (1 in 16.7)</b>	<b>7%</b>	<b>8%</b>

# SUMMIT CURVE

## Length of summit curve(L) for SSD

- Case-1(L > SSD)

$$L = \frac{NS^2}{(\sqrt{2H} + \sqrt{2h})^2}$$

or

$$L = \frac{NS^2}{4.4}$$

- Case-2(L < SSD)

$$L = 2S - \frac{(\sqrt{2H} + \sqrt{2h})^2}{N}$$

or

$$L = 2S - \frac{4.4}{N}$$

## length of summit curve for OSD

- Case-1(L > OSD)

$$L = \frac{NS^2}{8H}$$

or

$$L = \frac{NS^2}{9.6}$$

- Case-2(L < OSD)

$$L = 2S - \frac{8H}{N}$$

or

$$L = 2S - \frac{9.6}{N}$$

S=sight distance i.e. SSD, OSD or ISD

N= deviation angle

i.e. algebraic difference between two grade

H=height of driver eye above the carriageway i.e. 1.2 m

h=height of driver eye above the carriageway i.e. 0.15 m

# VALLEY CURVE

Length of valley curve for comfort condition:

$$L = 2 \left[ \frac{N \left( \frac{V}{3.6} \right)^3}{C} \right]^{\frac{1}{2}}$$

OR

$$L = 0.38 (NV^3)^{\frac{1}{2}}$$

N= deviation angle i.e. algebraic difference between two grade

C= rate of change of centrifugal acceleration may be taken as 0.6 m/sec<sup>3</sup>

V= speed of vehicle in kmph

## Length of valley curve for head light sight distance

- Case-1( $L > SSD$ )

$$L = \frac{NS^2}{(2h_1 + 2S \tan \alpha)}$$

OR

$$L = \frac{NS^2}{(1.5 + 0.035S)}$$

- Case-2( $L < SSD$ )

$$L = 2S - \frac{(2h_1 + 2S \tan \alpha)}{N}$$

OR

$$L = 2S - \frac{(1.5 + 0.035S)}{N}$$

$h_1$ =height of head light above the carriesway

$\alpha$ = inclination of focused portion of the beam of light w.r.t horizontal or beam angle .

$N$ = deviation angle i.e. algebraic difference between two grade.

$S$ =head light distance is equal to SSD

## Example -1

- A vertical summit curve is formed at the intersection of two gradient, +3% and -5%. Design the length of summit curve to provide a SSD for a design speed of 80 kmph. Assume any other data as per IRC.

## Example-2

- A vertical summit curve is to be designed when two grades, +1/50 and -1/80 meet on a highway. The SSD and OSD required are 180 and 640 m respectively. But due to the site conditions the length of the vertical curve has to be restricted to a maximum value of 500 m if possible. Calculate the length of the summit curve needed to fulfil the requirements of SSD , OSD or atleast OSD.

### Example-3

- A valley is formed by a descending grade of 1 in 25 meeting an ascending grade of 1 in 30. design the length of valley curve to fulfill both comfort condition and head light distance requirements for a design speed of 80 kmph. Assume allowable rate of change of centrifugal acceleration is  $0.6 \text{ m/sec}^3$

### Example-4

- An ascending gradient of 1 in 100 meets a descending gradient of 1 in 120. a summit curve is to be designed for a speed of 80 kmph so as to have an OSD of 470 m.

## Grade compensation

- At the horizontal curve, due to the turning angle  $\alpha$  of the vehicle, the curve resistance developed is equal to  $T(1 - \cos \alpha)$ . When there is a horizontal curve in addition to the gradient, there will be an increase in resistance to traction due to both gradient and curve. It is necessary that in such cases the total resistance due to grade and the curve should not exceed the resistance due to maximum value of the gradient specified.
- Maximum value generally taken as **ruling gradient**



## Cont....

- Thus grade compensation can be defined as the reduction in gradient at the horizontal curve because of the additional tractive force required due to curve resistance ( $T - T \cos \alpha$ ), which is intended to offset the extra tractive force involved at the curve.
- IRC gave the following specification for the grade compensation.
  1. Grade compensation is not required for grades flatter than 4% because the loss of tractive force is negligible.
  2. Grade compensation is  $(30+R)/R$  %, where 'R' is the radius of the horizontal curve in meters.
  3. The maximum grade compensation is limited to  $75/R$ %.



## Example-1

- While aligning a hilly road with a ruling gradient of 6%, a horizontal curve of radius 60 m is encountered. Find the compensated gradient at the curve.

# Bibliography

- Khanna, S. K., & Justo, C. E. G. *“Highway engineering”*. Nem Chand & Bros.
- *IRC Codes*.

## PAVEMENT

- **pavement** is the durable surface material laid down on an area intended to sustain vehicular load or foot traffic, such as a road or walkway.
- It is of two types
  - **Flexible pavement** or bituminous pavement or black top pavement
  - **Rigid pavement** or cement concrete pavement or white surface pavement

## COMPARISON OF FLEXIBLE PAVEMENT & RIGID PAVEMENT

### FLEXIBLE PAVEMENT

1. Have low flexural strength
2. Load is transferred by grain to grain contact
3. Surfacing cannot be laid directly on the sub grade but a sub base is needed
4. No thermal stresses are induced
5. expansion joints are not needed
6. Design life 10-15 years
7. Initial cost of construction is low
8. Maintenance cost is high
9. Road can be used for traffic within 24 hours
10. Damaged by Oils and Certain Chemicals

### RIGID PAVEMENT

1. Have more flexural strength
2. No such phenomenon of grain to grain load transfer exists
3. Surfacing can be directly laid on the sub grade
4. Thermal stresses are induced
5. expansion joints are needed
6. Design life 20-30 years
7. Initial cost of construction is high
8. Less maintenance cost
9. Road cannot be used until 14 days of curing
10. No Damage by Oils and other chemicals



Rigid  
Pavement



Flexible  
pavement

An aerial photograph of a multi-lane highway curving through a dry, grassy landscape. The road is divided into two sections: a darker, smoother section on the left and a lighter, more textured section on the right. Two callout boxes with orange borders and white backgrounds point to these sections. The left callout box contains the text 'Flexible pavement' and points to the darker section. The right callout box contains the text 'Rigid pavement' and points to the lighter section. The sky is clear and blue, and the surrounding terrain is flat with sparse vegetation.

Flexible  
pavement

Rigid  
pavement



## Requirements of a pavement

- Sufficient thickness to distribute the wheel load stresses to a safe value on the sub-grade soil.
- Structurally strong to withstand all types of stresses imposed upon it.
- Adequate coefficient of friction to prevent skidding of vehicles.
- Smooth surface to provide comfort to road users even at high speed.
- Produce least noise from moving vehicles.
- Dust proof surface so that traffic safety is not impaired by reducing visibility.
- Impervious surface, so that sub-grade soil is well protected.
- Long design life with low maintenance cost.

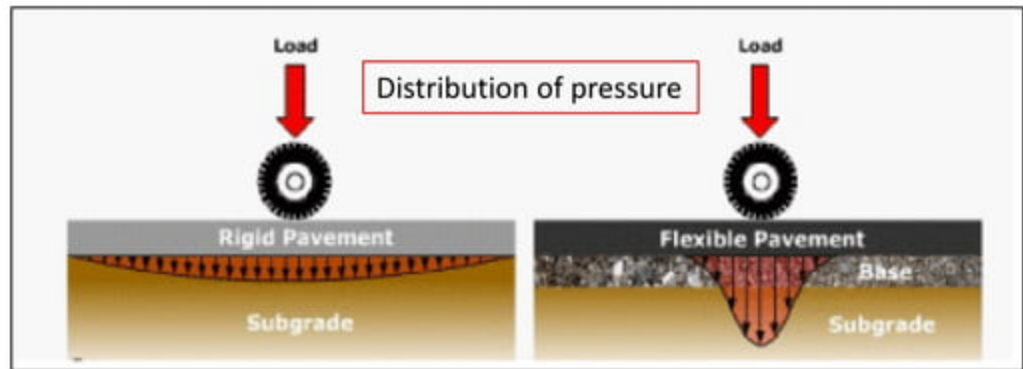
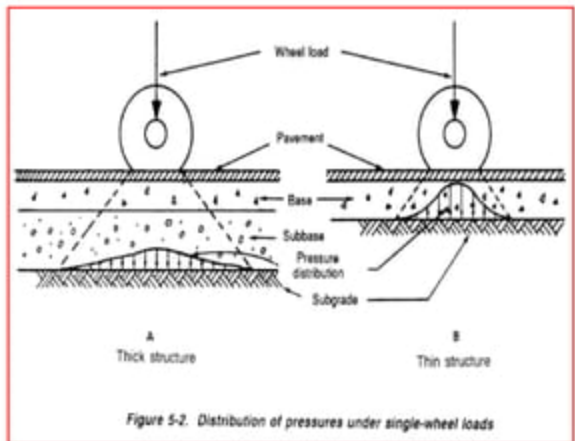
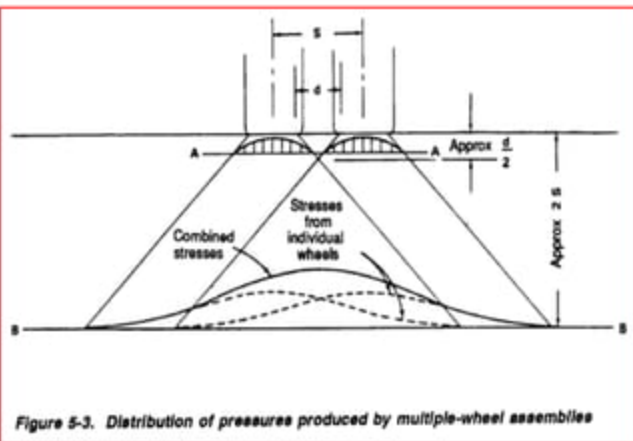

## Types of flexible pavements

- Conventional layered flexible pavement
- Full - depth asphalt pavement
- Contained rock asphalt mat (CRAM).
- **Conventional flexible pavements** are layered systems with high quality expensive materials are placed in the top where stresses are high, and low quality cheap materials are placed in lower layers.
- **Full - depth asphalt pavements** are constructed by placing bituminous layers directly on the soil sub-grade. This is more suitable when there is high traffic and local materials are not available.
- **Contained rock asphalt mats** are constructed by placing dense/open graded aggregate layers in between two asphalt layers.

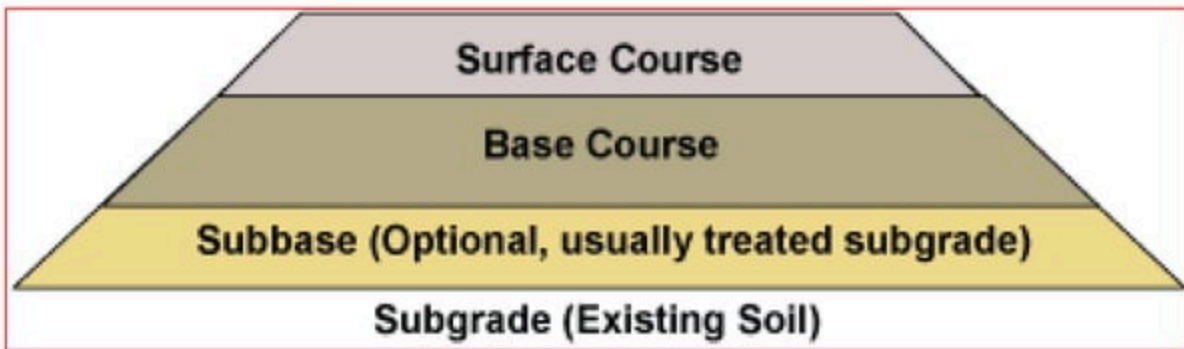

**c/s of flexible pavement**

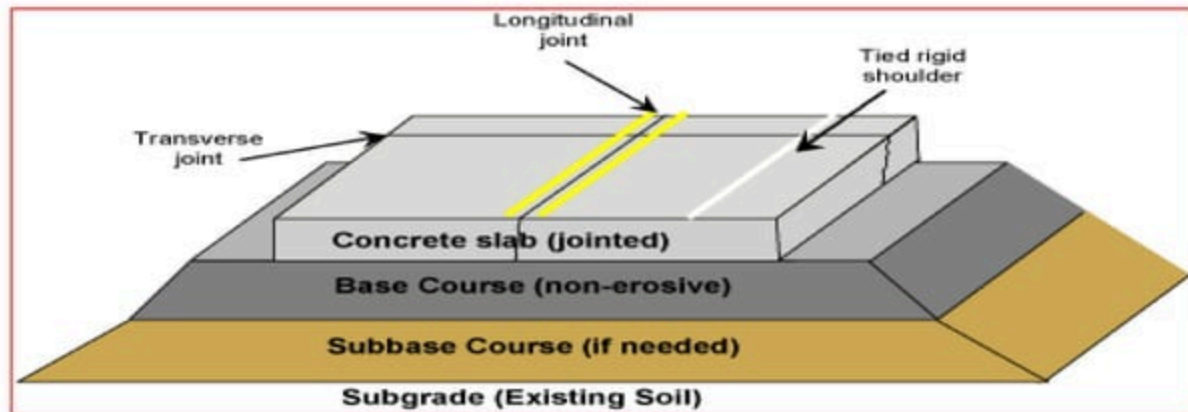

**c/s of rigid pavement**

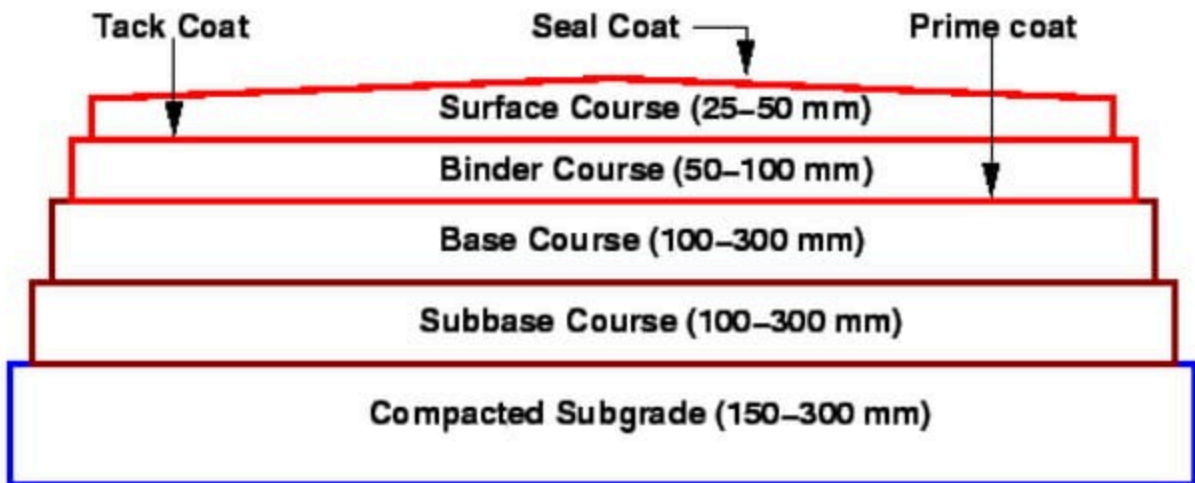

Natural Subgrade

c/s of flexible pavement

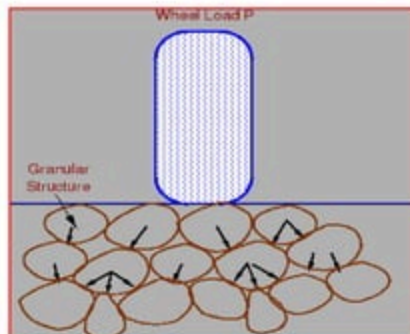

Load is transferred by grain to grain contact

## Typical layers of a flexible pavement

**Seal Coat:** Seal coat is a thin surface treatment used to waterproof the surface and to provide skid resistance and to seal the surfacing against the ingress of water.

**Tack Coat:** Tack coat is a very light application of asphalt, usually asphalt emulsion diluted with water. It provides proper bonding between two layer of binder course.it is generally applied on impervious surface.

**Prime Coat:** Prime coat is an application of low viscous liquide bituminous material over an existing porous or absorbent pavement surface like WBM.

- Prime objective is to plug the capillary voids of the porous surface and to bond the loose materials on the existing surface like granular bases on which binder layer is placed. It provides bonding between two layers.



Prime  
coat

Seal coat



# Typical layers of a flexible pavement

## Surface course:

- Surface course is the layer directly in contact with traffic loads and generally contains superior quality materials. They are usually constructed with dense graded asphalt concrete(AC).
- It provides characteristics such as friction, smoothness, drainage, etc. Also it will prevent the entrance of excessive quantities of surface water into the underlying base, sub-base and sub-grade,
- It provides a smooth and skid-resistant riding surface,
- It must be water proof to protect the entire base and sub-grade from the weakening effect of water.



# Typical layers of a flexible pavement

## Binder course:

- This layer provides the bulk of the asphalt concrete structure. It's chief purpose is to distribute load to the base course.
- The binder course generally consists of aggregates having less asphalt and doesn't require quality as high as the surface course, so replacing a part of the surface course by the binder course results in more economical design.

## Base course:

- The base course is the layer of material immediately beneath the surface of binder course and it provides additional load distribution and contributes to the sub-surface drainage. It may be composed of crushed stone and other untreated or stabilized materials.

## Typical layers of a flexible pavement

- **Sub-Base course:** The sub-base course is the layer of material beneath the base course and the primary functions are to provide structural support, improve drainage.
  - It may WBM or WMM
  - A sub-base course is not always needed or used. For example, a pavement constructed over a high quality.
- **Sub-grade:** The top soil or sub-grade is a layer of natural soil prepared to receive the stresses from the layers above. It is essential that at no time soil sub-grade is overstressed.
  - It should be compacted to the desirable density, near the optimum moisture content.

## Types of Rigid Pavements

- Jointed plain concrete pavement (JPCP),
- Jointed reinforced concrete pavement (JRCP),
- Continuous reinforced concrete pavement (CRCP)
- Pre-stressed concrete pavement (PCP).

# Types of Rigid Pavements

- **Jointed Plain Concrete Pavement:** constructed with closely spaced contraction joints. Dowel bars or aggregate interlocks are normally used for load transfer across joints. They normally has a joint spacing of 5 to 10m.
- **Jointed Reinforced Concrete Pavement:** reinforcements do not improve the structural capacity significantly but they can drastically increase the joint spacing to 10 to 30m. Dowel bars are required for load transfer. Reinforcements help to keep the slab together even after cracks.
- **Continuous Reinforced Concrete Pavement:** Complete elimination of joints are achieved by reinforcement.

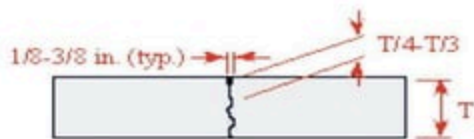

**Undoweled - Transverse (Type A-1)**

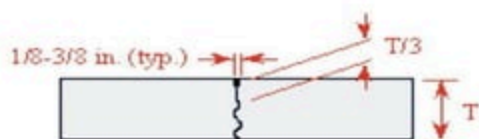

**Untied - Longitudinal (Type A-3)**

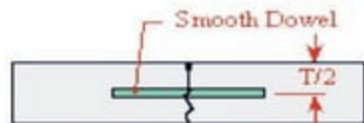

**Doweled - Transverse (Type A-2)**



**Tied - Longitudinal (Type A-4)**

*Note: T = Thickness of Concrete Slab*

## Top View

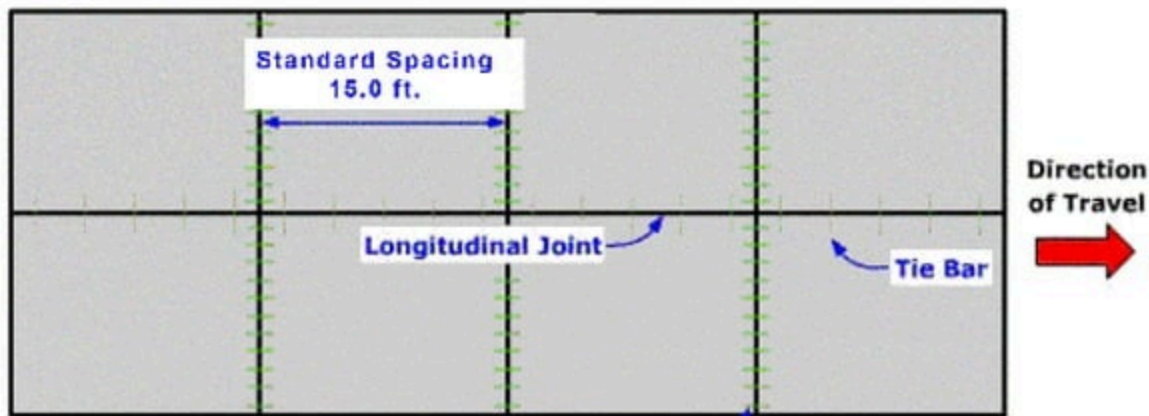

## Side View

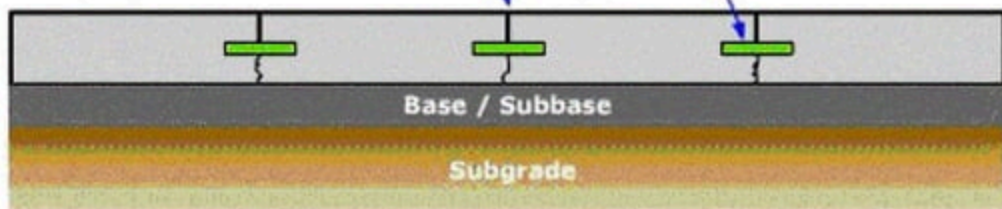

Longitudinal  
joint

Rigid  
pavement

Transverse  
joint



Granular materials



# Bibliography

- Khanna, S. K., & Justo, C. E. G. *“Highway engineering”*. Nem Chand & Bros.
- *IRC Codes*.



**FLEXIBLE PAVEMENT**

**RIGID PAVEMENT**

# Types of Pavements

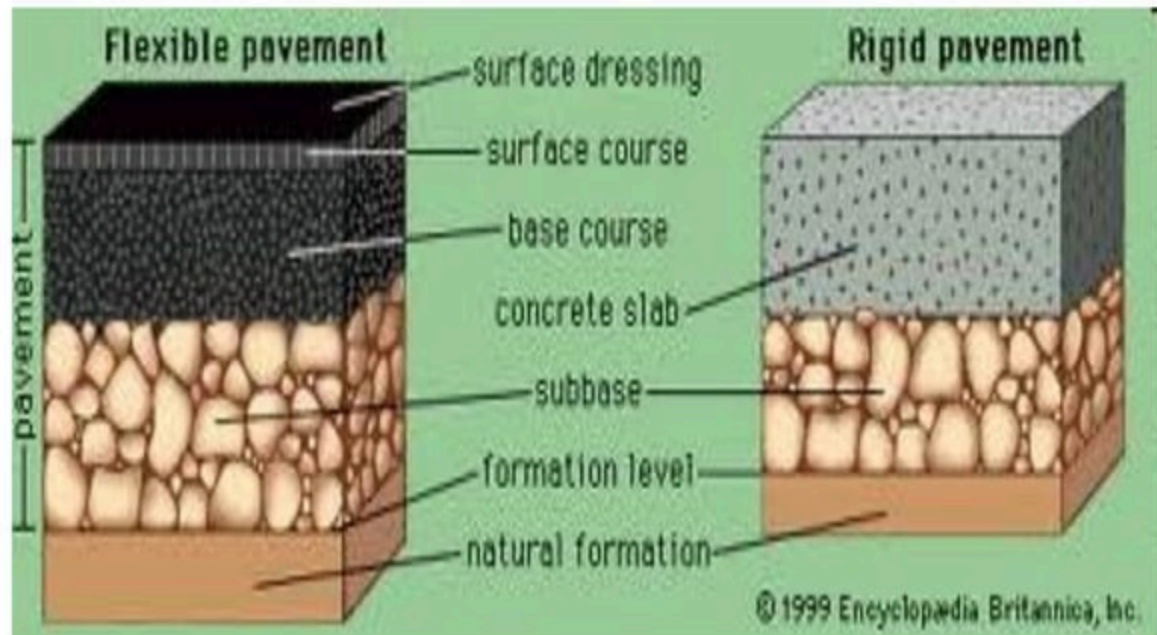

Wheel Load P



Granular Structure

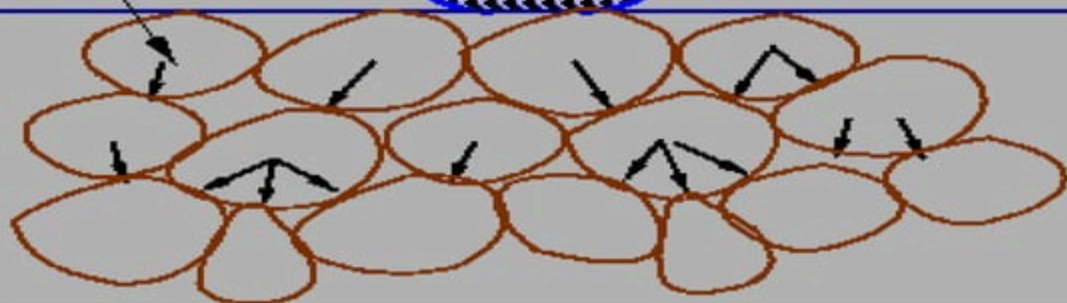

# Wheel Load Distribution

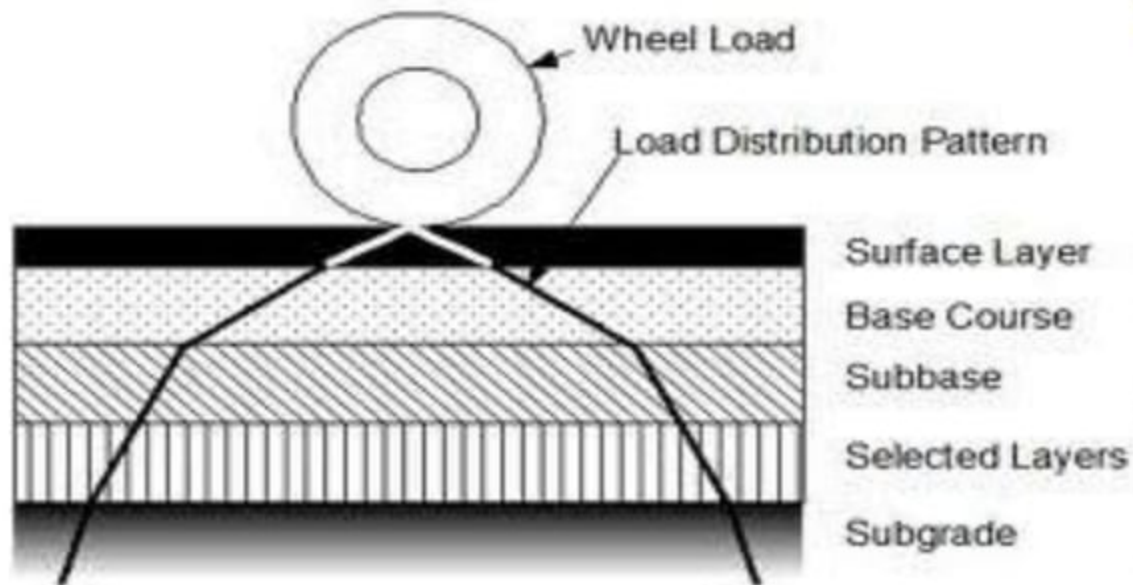

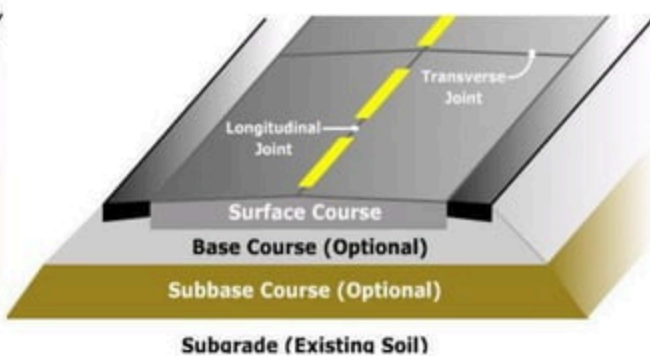
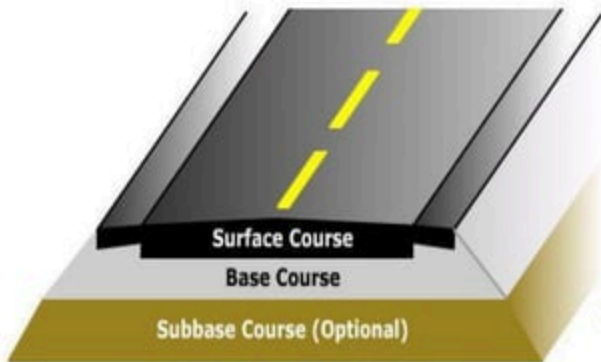

Subgrade (Existing Soil)



Flexible

Load

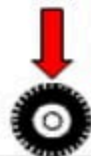

Rigid

- Jointed Plain Concrete Pavement (JPCP)

Top View

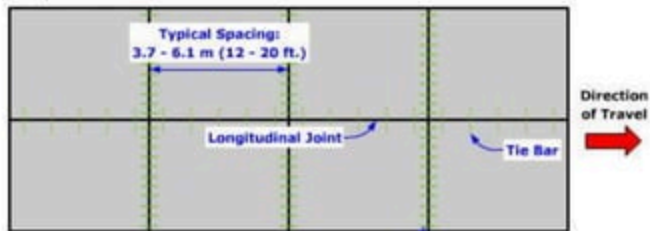

Side View

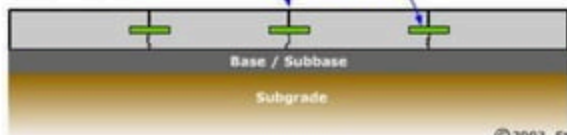

© 2003 Steve Muench



# Jointed CC Pavement

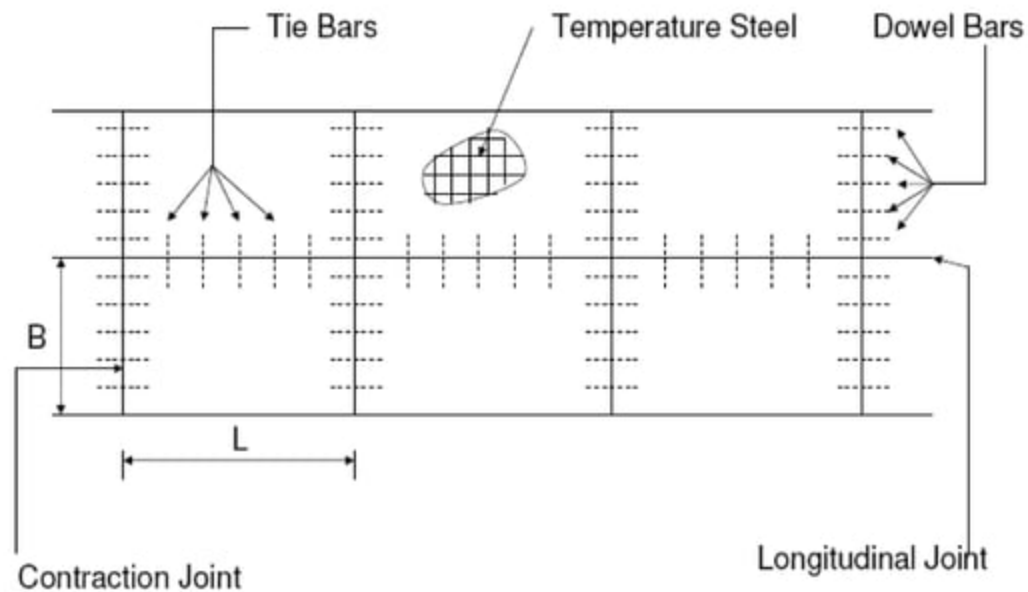



# LOAD DISTRIBUTION

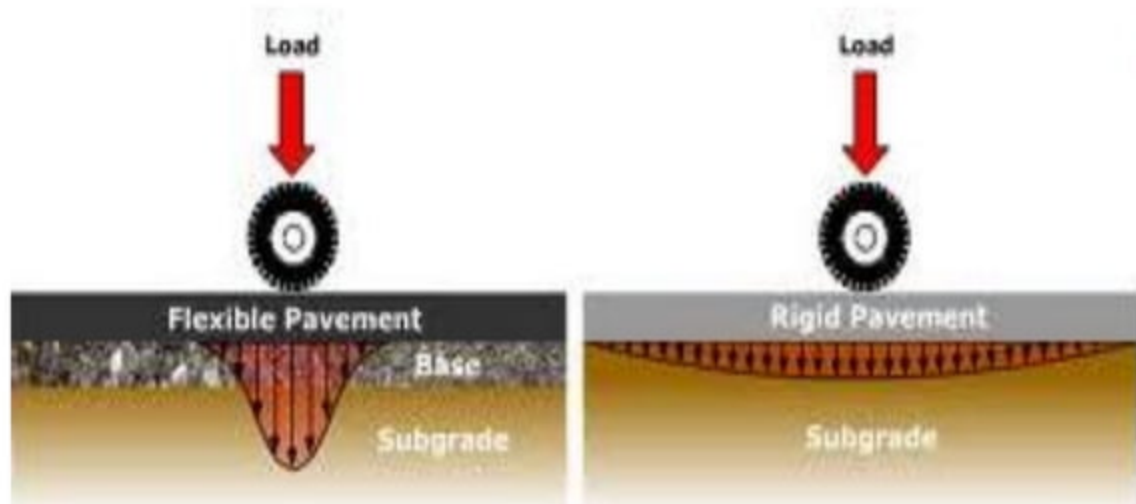
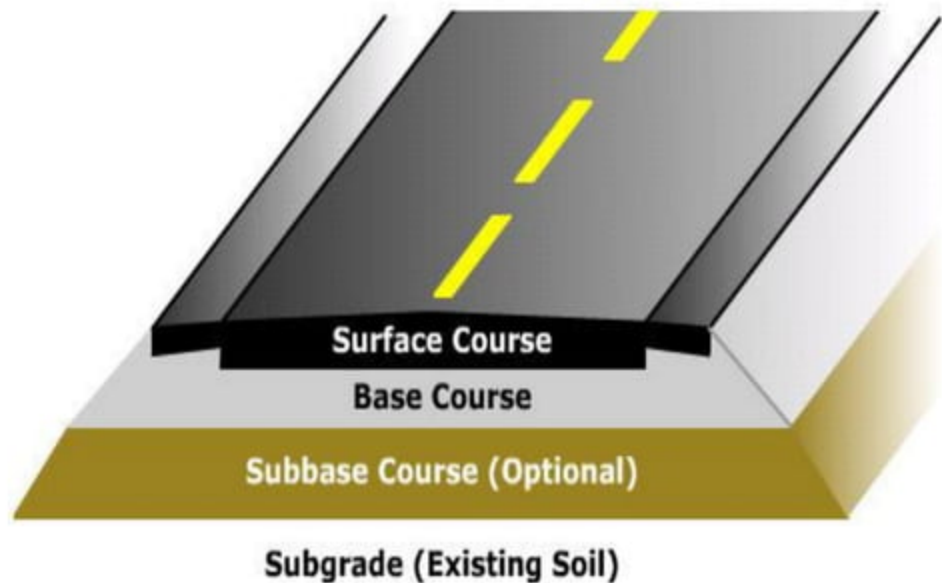

Figure 1: Rigid and Flexible Pavement Load Distribution

# Components of Flexible Pavement



## Function and Significance of Subgrade Properties

- Basement soil of road bed.
- Important for structural and pavement life.
- Should not deflect excessively due to dynamic loading.
- May be in fill or embankment.



# Flexible Pavement Design

**IRC (37-2001)**

## **Basic Principles**

- **Vertical stress or strain on sub-grade**
- **Tensile stress or strain on surface course**

# Factors for design of pavements

- Design wheel load
  - Static load on wheels
  - Contact Pressure
  - Load Repetition
- Subgrade soil
  - Thickness of pavement required
  - Stress- strain behavior under load
  - Moisture variation
- Climatic factors:(rain fall)
- Pavement component materials
- Environment factors:(height of embankment and its detailed)
- Traffic Characteristics
- Required Cross sectional elements of the alignment

# Pavement Responses Under Load

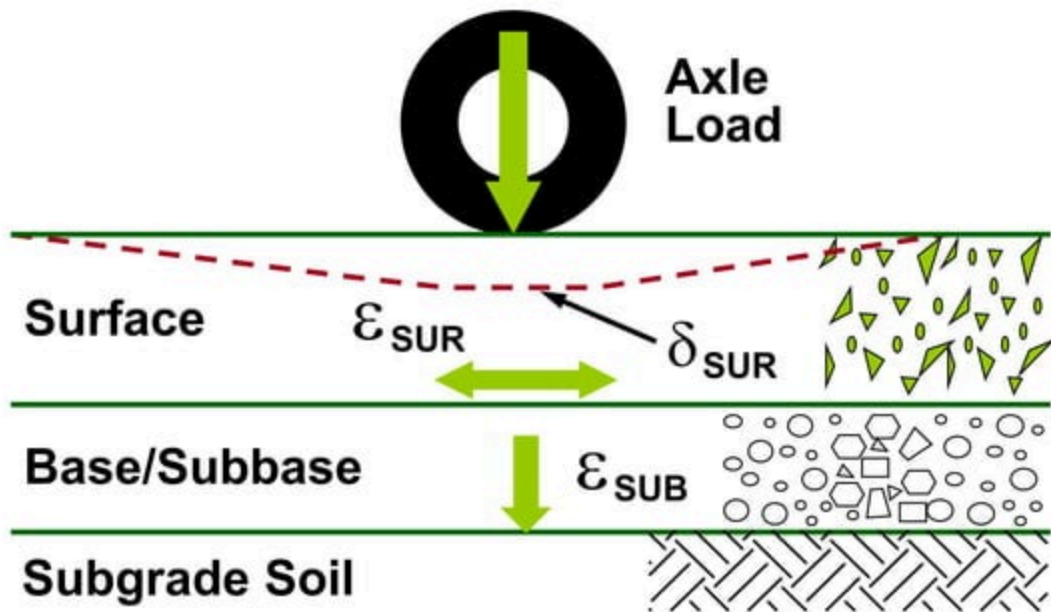

# Axle Configurations

An **axle** is a central shaft for a rotating wheel or gear



**Single Axle With Single Wheel**  
(Legal Axle Load = 6t)



**Single Axle With Dual Wheel**  
(Legal Axle Load = 10t)

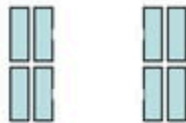

**Tandem Axle**  
(Legal Axle Load = 18t)

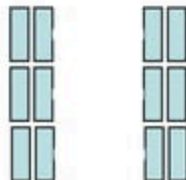

**Tridem Axle**  
(Legal Axle Load = 24t)





# Truck Configuration

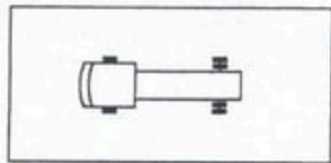

2 Axle Truck – 16t

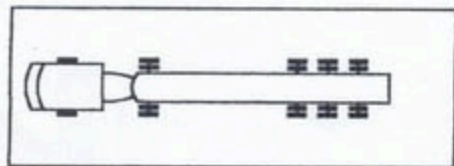

5 Axle Truck – 40t

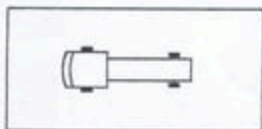

LCV

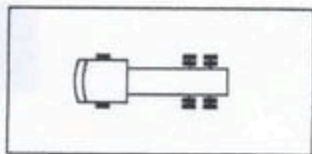

3 Axle Truck – 24t

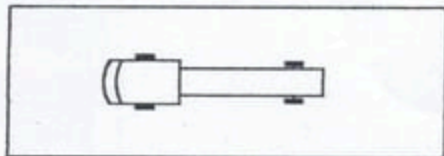

4 Axle Semi Articulated – 34t

# Standard Axle

Single axle with dual wheels carrying a load of 80 kN (8 tonnes) is defined as standard axle

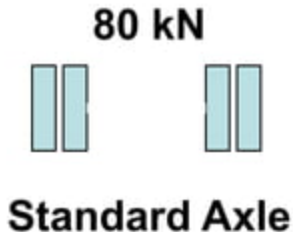

# Evaluation Of Pavement Component Layers

- **Sub-grade**

- **To Receive Layers of Pavement Materials Placed over it**
- **Plate Bearing Test**
- **CBR Test**
- **Triaxial Compression**

# Flexible Pavement Design Using CBR Value Of Sub-grade Soil

- **California State Highways  
Department Method**
- **Required data**
  - ❖ Design Traffic in terms of  
cumulative number of standard  
**axles(CSA)**
  - ❖ CBR value of subgarde

# Traffic Data

- Initial data in terms of number of commercial vehicles per day (CVPD).
- Traffic growth rate during design life in %
- Design life in number of years.
- Distribution of commercial vehicles over the carriage way

## Traffic – In Terms Of CSA (8160 Kg) During Design Life

- **Initial Traffic**
  - **In terms of Cumulative Vehicles/day**
  - **Based on 7 days 24 hours Classified Traffic**
- **Traffic Growth Rate**
  - **7.5 % may be Assumed**

## Design Life

- **National Highways – 15 Years**
- **Expressways and Urban Roads – 20 Years**
- **Other Category Roads – 10 – 15 Years**

## Vehicle Damage Factor (VDF)

❖ Multiplier to Convert No. of Commercial Vehicles of Different Axle Loads and Axle Configurations to the Number of Standard Axle Load Repetitions indicate VDF Values

❖ Normally =  $(\text{Axle Load}/8.2)^n$

$$n = 4 - 5$$



## INDICATIVE VDF VALUES

Initial Traffic in terms of CV/PD	Terrain	
	Plain/Rolling	Hilly
0 – 150	1.5	0.5
150 – 1500	3.5	1.5
> 1500	4.5	2.5

# Distribution Of Traffic

## Single Lane Roads:

→ Total No. of Commercial Vehicles in both Directions

## Two-lane Single Carriageway Roads:

→ 75% of total No. of Commercial Vehicles in both Directions

## Four-lane Single Carriageway Roads:

→ 40% of the total No. of Commercial Vehicles in both Directions

## Dual Carriageway Roads:

→ for two lane dual carriage way 75% of the No. of Commercial Vehicles in each Direction

→ For three lane-60%

→ For four lane-45%

# Computation of Traffic for Use of Pavement Thickness Design Chart

$$N = \frac{365 \times A[(1+r)^n - 1]}{r} \times D \times F$$

**N** = Cumulative No. of standard axles to be catered for the design in terms of msa

**D** = Lane distribution factor

**A** = Initial traffic, in the year of completion of construction, in terms of number of commercial vehicles per day  
 $= p(1-r)^x$

**P** = no. of commercial vehicle as per last count

**X** = no. of year between the last count and the year of completion of construction

**F** = Vehicle Damage Factor

**n** = Design life in years

**r** = Annual growth rate of commercial vehicles

# CBR Testing Mach

## Definition:

It is the ratio of force per unit area required to penetrate a soil mass with standard circular piston at the rate of 1.25 mm/min. to that required for the corresponding penetration of a standard material.

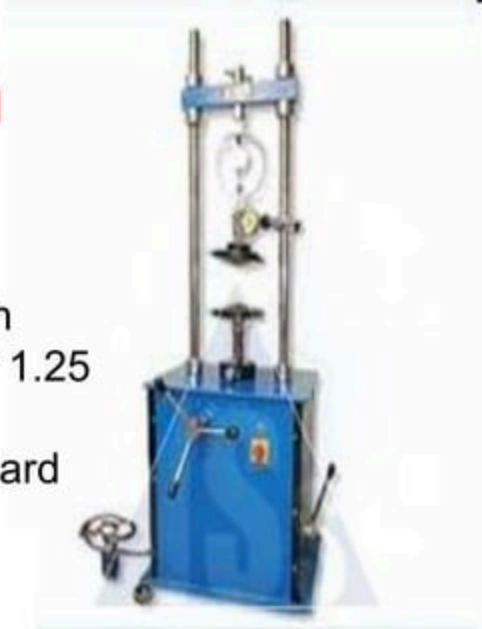
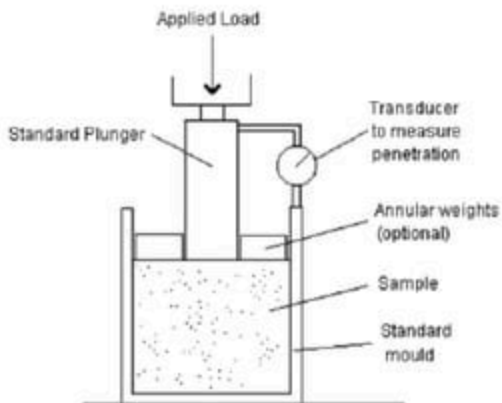

# Subgrade

- **Soak the Specimen in Water for FOUR days and CBR to be Determined.**
- **Use of Expansive Clays NOT to be Used as Sub-grade**
- **Non-expansive Soil to be Preferred.**

# Subgrade

- **Subgrade to be Well Compacted to Utilize its Full Strength**
- **Top 500 mm to be Compacted to 97% of MDD (Modified Proctor).**
- **Material Should Have a Dry Density of 1.75 gm/cc.**

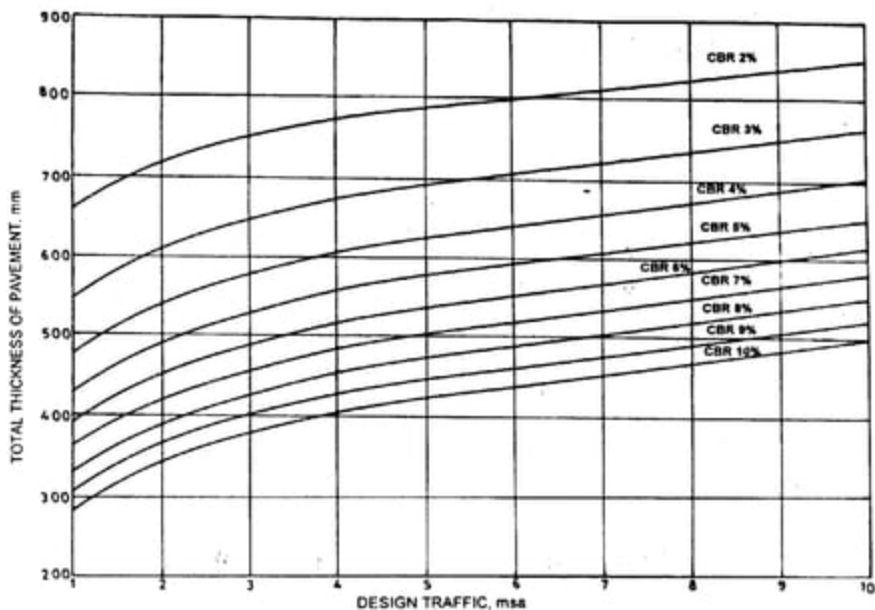

Pavement Thickness Design Chart for Traffic 1-10 msa

**Flexible pavement design chart (IRC) (for CSA < 10 msa)**

**PAVEMENT DESIGN CATALOGUE**  
**RECOMMENDED DESIGNS FOR TRAFFIC RANGE 1-10 msa**

<b>CBR 6%</b>					
Cumulative Traffic (msa)	Total Pavement Thickness (mm)	<b>PAVEMENT COMPOSITION</b>			
		Bituminous Surfacing		Granular Base (mm)	Granular Sub-base (mm)
		Wearing Course (mm)	Binder Course (mm)		
1	390	20 PC		225	165
2	450	20 PC	50 BM	225	175
3	490	20 PC	50 BM	250	190
5	535	25 SDBC	50 DBM	250	210
10	615	40 BC	65 DBM	250	260

**Flexible Pavement Layers (IRC) (CSA < 10 msa)**



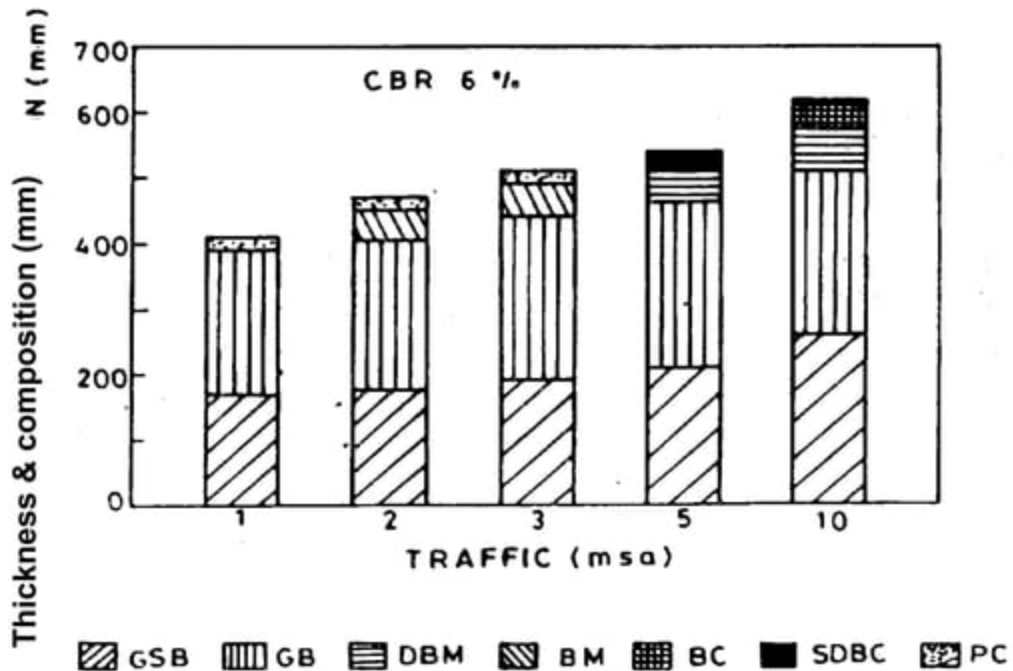

**Flexible Pavement Layers (IRC) (CSA < 10 msa)**

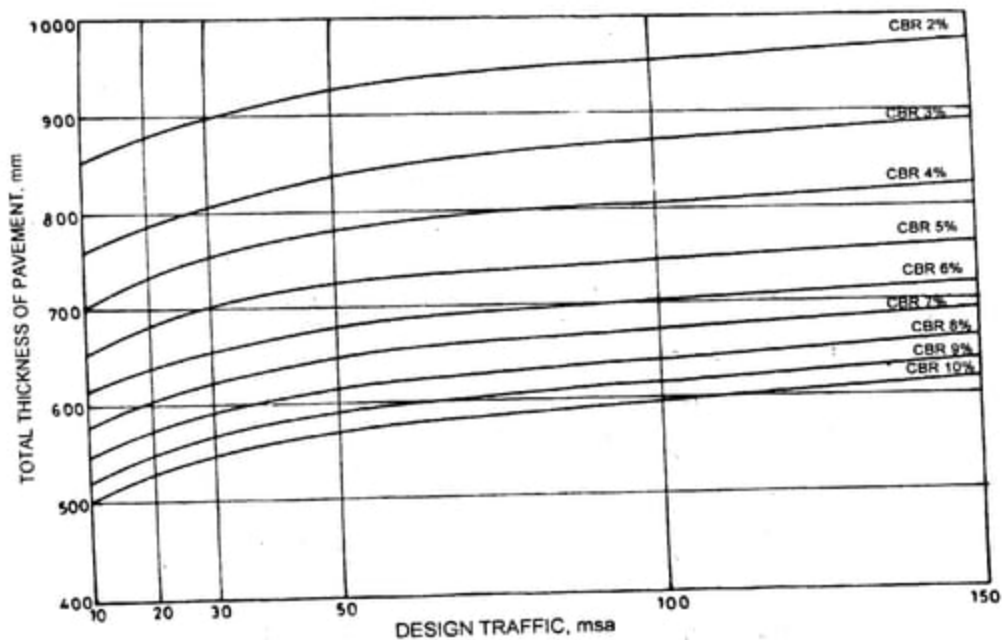

Pavement Thickness Design Chart for Traffic 10-150 msa

## Flexible pavement design chart (IRC)

**PAVEMENT DESIGN CATALOGUE**  
**RECOMMENDED DESIGNS FOR TRAFFIC RANGE 10-150 msa**

<b>CBR 6%</b>				
<b>Cumulative Traffic (msa)</b>	<b>Total Pavement Thickness (mm)</b>	<b>PAVEMENT COMPOSITION</b>		
		<b>Bituminous Surfacing</b>		<b>Granular Base &amp; Sub-base (mm)</b>
		<b>BC (mm)</b>	<b>DBM (mm)</b>	
10	615	40	65	Base = 250  Sub-base = 260
20	640	40	90	
30	655	40	105	
50	675	40	125	
100	700	50	140	
150	720	50	160	

**Flexible pavement layers (IRC)**

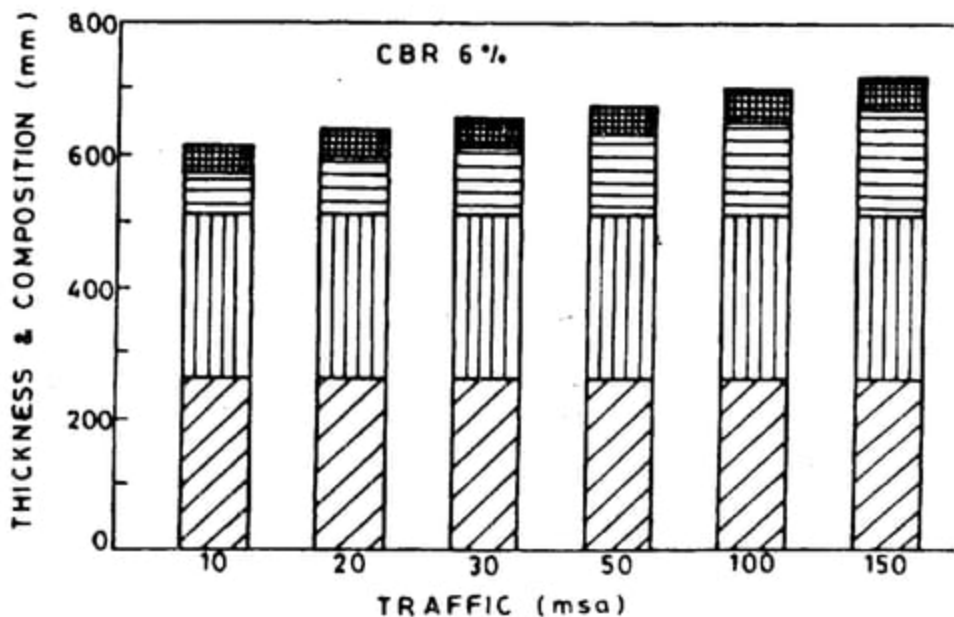

GSB
  GB
  DBM
  BC

**Flexible pavement layers (IRC)**

## Sub-base

- **Material – Natural Sand, Moorum, Gravel, Laterite, Kankar, Brick Metal, Crushed Stone, Crushed Slag, Crushed Concrete**
- **GSB- Close Graded / Coarse Graded**
- **Parameters – Gradation, LL, PI, CBR**
- **Stability and Drainage Requirements**

## Sub-base

- **Min. CBR 20 % - Traffic up-to 2 msa**
- **Min. CBR 30 %- Traffic > 2 msa**
- **If GSB is Costly, Adopt WBM, WMM**
- **Min. Thickness – 150 mm - <10 msa**
- **Min. Thickness – 200 mm - >10 msa**

## Sub-base

- Min. CBR – 2 %
- If CBR < 2% - Pavement Thickness for 2 % CBR + Capping layer of 150 mm with Min. CBR 10% (in addition to the Sub-Base)
- In case of Stage Construction – Thickness of GSB for Full Design Life

## Base Course

- Unbound Granular Bases – WBM / WMM or any other Granular Construction
- Min. Thickness – 225 mm –  $< 2$  msa
- Min. Thickness – 250 mm -  $> 2$  msa
- WBM – Min. 300 mm ( 4 layers – 75mm each)



## Example-1

- Design the pavement for construction of a new bypass with the following data:
  - ✓ Two lane single carriage way
  - ✓ Initial traffic in a year of completion of construction work (sum of both directions) = 400 CVPD
  - ✓ Traffic growth rate per annum = 7.5 percent
  - ✓ Design life = 15 years
  - ✓ Vehicle damage factor = 2.5  
(standard axles per commercial vehicle)
  - ✓ Design CBR value of sub-grade soil = 4 %

## Example-2

- Design the flexible pavement For Widening An Existing 2-lane NH-5 To 4-lane Divided Road
  - ✓ 4-lane divided carriageway
  - ✓ Initial traffic in a year of commencement of construction work (sum of both directions) = 5600CVPD
  - ✓ Completion of construction work=2.5 years
  - ✓ Design life= 10/15yrs
  - ✓ Design CBR of sub-grade soil = 5 %
  - ✓ Traffic growth rate = 8 %
  - ✓ Vehicle damage factor = 4.5 (Found out from axle road survey axles per CV on existing road)

# Design of rigid pavement as per IRC-58:2002

- Stress acting on the rigid pavement are:
  - Wheel load stress
    - ✓ Interior loading
    - ✓ Edge loading
    - ✓ Corner loading
  - Temperature stress
    - ✓ Warping stress
    - ✓ Frictional stress

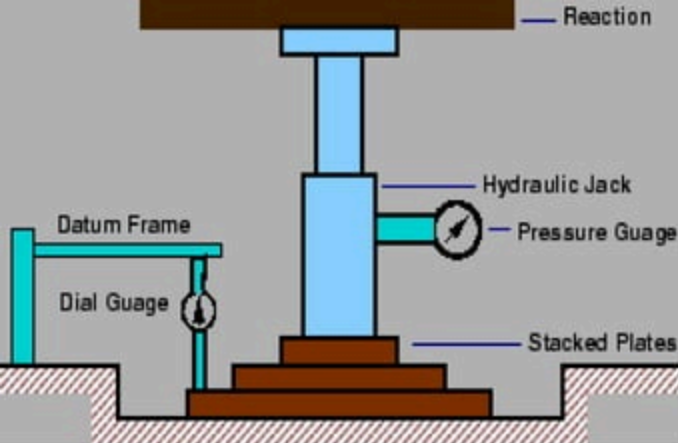

## Radius of relative stiffness:

$$l = \left[ \frac{Eh^3}{12k(1-\mu^2)} \right]^{\frac{1}{4}}$$

- Where
- $l$  = Radius of relative stiffness
- $E$  = modulus of elasticity of cement concrete ,  $\text{kg/cm}^2$
- $\mu$  = poisson's ratio for concrete = 0.15
- $h$  = slab thickness, cm
- $K$  = modulus of subgrade reaction,  $\text{kg/cm}^3$

## Westergaard's stress equation for wheel load

- Stress at the interior (**S<sub>i</sub>**)

$$s_i = \frac{0.316P}{h^2} \left[ 4 \log_{10} \left( \frac{l}{b} \right) + 1.069 \right]$$

- Stress at the edge (**S<sub>e</sub>**)

$$s_e = \frac{0.572P}{h^2} \left[ 4 \log_{10} \left( \frac{l}{b} \right) + 0.359 \right]$$

- Stress at the corner (**S<sub>c</sub>**)

$$s_c = \frac{3P}{h^2} \left[ 1 - \left( \frac{a\sqrt{2}}{l} \right)^{0.6} \right]$$

## Where,

- $P$  = design wheel load, kg
- $l$  = Radius of relative stiffness
- $E$  = modulus of elasticity of cement concrete ,  
kg/cm<sup>2</sup>
- $\mu$  = poisson's ratio for concrete = 0.15
- $h$  = slab thickness, cm
- $K$  = modulus of subgrade reaction, kg/cm<sup>3</sup>
- $b$  = radius of equivalent distribution of pressure, cm
  - $b = a$  , if  $a/h \geq 1.724$
  - $b = \sqrt{(1.6 a^2 + h^2)} - 0.675 h$  , when  $a/h < 1.724$
- $a$  = radius of load contact, cm

## Modified Westergaard's stress equation for wheel load

- Modified by '*Teller*'

$$s_e = \frac{0.572P}{h^2} (1 + 0.54\mu) \times \left( 4 \log_{10} \left( \frac{l}{b} \right) + \log_{10} b - 0.4048 \right)$$

- Modified by '*Kelley*'

$$s_c = \frac{3P}{h^2} \left[ 1 - \left( \frac{a\sqrt{2}}{l} \right)^{1.2} \right]$$



## Warping stress(given by 'Bradbury')

- Stress at the interior( $st_i$ )

$$st_i = \frac{Eet}{2} \left[ \frac{c_x + \mu c_y}{1 - \mu^2} \right]$$

- Stress at the edge ( $st_e$ )

$$st_e = \frac{C_x Eet}{2} \quad \text{or} \quad st_e = \frac{C_y Eet}{2}$$

Whichever is higher

- Stress at the corner ( $st_c$ )

$$st_c = \frac{Eet}{3(1 - \mu)} \sqrt{\frac{a}{l}}$$

## Where,

- $E$  = modulus of elasticity of cement concrete ,  $\text{kg/cm}^2$
- $e$  = thermal coefficient of concrete per  $^{\circ}\text{C}$
- $t$  = temperature difference between the top and bottom of the slab in degree C
- $\mu$  = poisson's ratio for concrete = 0.15
- $C_x$  = Bradbury coefficient based on  $L/l$  in desire direction ([IRC-58:2002](#))
- $C_y$  = Bradbury coefficient based on  $B/l$  in right angle to the desire direction ([IRC-58:2002](#))
- $L$  = length of slab, m
- $B$  = width of slab, m

# Frictional stress

- Frictional stress( $s_f$ )

$$s_f = \frac{WLf}{2 \times 10^4}$$

- Where,
- $s_f$  = unit stress developed in CC pavement, kg/cm<sup>2</sup>
- $W$  = unit wt. of concrete, (about 2400 kg/cm<sup>2</sup>)
- $L$  = length of slab, m
- $B$  = width of slab, m

## Example-1

- Calculate the stress at interior, edge and corner regions of a cement concrete pavement using westergaard's equation. Use the following data
  - ✓ Wheel load,  $P=5100\text{kg}$
  - ✓ Modulus of elasticity of concrete,  $E=3.0 \times 10^5 \text{ kg/cm}^2$
  - ✓ Pavement thickness,  $h=18\text{cm}$
  - ✓ Poisson's ratio=0.15
  - ✓ Modulus of subgrade reaction= $6.0 \text{ kg/cm}^3$
  - ✓ Radius of contact area=15 cm

## Example-2

- Compute the radius of relative stiffness of 15 cm thick cement concrete slab from the following data
  - $E=21000\text{kg/cm}^2$
  - Poisson's ratio=0.13
  - $K=3\text{KG/cm}^2$  or  $7.5 \text{ kg/cm}^2$

## Example-3

- Determine the warping stress at interior, edge and corner regions in a 25 cm thick cement concrete pavement with transverse joint at 9 m interval and longitudinal joint at 3.6 m intervals. The modulus of subgrade reaction is  $6.9 \text{ kg/cm}^2$ . Assume temperature difference for day condition to be  $0.6^\circ\text{C}$  per cm of the slab thickness. Assume radius of loaded area as 15 cm for computing warping stress at the corner.
- $E = 3 \times 10^5 \text{ kg/cm}^2$
- $e = 10 \times 10^{-6} \text{ per } ^\circ\text{C}$
- $\mu = 0.15$

# Example-4

- A CC pavement slab thickness 20cm is constructed over a granular subbase having modulus of subgrade reaction 15 kg/cm<sup>2</sup>. the maximum temperature difference between the top and bottom of the slab during summer day and night is found to be 18°C. The spacing between the transverse contraction joint is 4.5 m and that between the longitudinal joint is 3.5 m. the design wheel load is 5100 kg, radius of contact area is 15 cm. the coefficient of thermal expansion of CC IS  $10 \times 10^{-6}$  per °C and friction coefficient is 1.5. calculate the warping stress at edge, interior, corner and also calculate the friction stress.
- $E = 3 \times 10^5$  kg/cm<sup>2</sup>
- $\mu = 0.15$

## Bibliography

- Khanna, S. K., & Justo, C. E. G. "*Highway engineering*". *Nem Chand & Bros.*
- *IRC Codes.*

# Traffic Engineering

- It is the science of measuring traffic and travel, the study of the basic laws relating to traffic flow and generation and application of this knowledge to the professional practice of planning, designing and operating traffic systems to achieve safe and efficient movement of persons and goods.
- Objective of traffic engineering:
  - Achieve efficient 'free and rapid' flow of traffic
  - Reduce the no. of accidents.
- Various phases of traffic engineering are: (3Es)
  - Engineering (constructive i.e. geometric design of road)
  - Enforcement (traffic laws, regulation and control)
  - Education (publicity and through school and television)



## Scope of traffic engg.

- **Traffic characteristics**:-improvement of traffic facilities( vehicle , human[road user])
- **Traffic studies and analysis**
- **Traffic operation**-control and regulation:- laws of speed limit, installation of traffic control device
- **Planning and analysis**
- **Geometric design**:-Horizontal and vertical curve design
- **Administration and management**:- '3E'concept

# Traffic characteristics

- Road user characteristics
  - Physical
  - Mental
  - Psychological
  - Environmental
- Vehicular characteristics
  - Vehicle dimension
  - Weight of loaded vehicle
  - Power of vehicle
  - Speed of vehicle
  - Braking characteristics

# Traffic studies

- Traffic studies are carried out to analyse the traffic characteristics. These studies help in deciding the geometric design features traffic control for safe and efficient traffic movement.
- The various traffic survey studies generally carried out are:
  - ✓ Traffic volume study
  - ✓ Speed study
    - ✓ Spot speed study
    - ✓ Speed and delay study
  - ✓ Origin and destination study
  - ✓ Traffic flow characteristics
  - ✓ Traffic capacity study
  - ✓ Parking study
  - ✓ Accident studies

## Traffic volume study

- It is the number of vehicles crossing a section of road per unit time at any selected period.
- It is used as a quantity measure of flow: the commonly units are vehicles/day or vehicles/hour
- The objects and the used of traffic volume study are:
  - It is generally accepted as a true measure of the relative importance of roads and in deciding the priority for improvement and expansion.
  - It is used in planning, traffic operation and control of existing facilities and also for planning the new facilities.

## Cont..

- It is used in the analysis of traffic patterns and trends.
- Useful in structural design of pavement
- Used in planning one-way streets and other regulatory measure.
- Turning movement study used in the design of intersections, in planning signal timings, channelization and control devices.
- Pedestrian traffic volume study is used for planning side walk, cross walks, subway and pedestrian signals.

# Counting of traffic volume

- Mechanical count

- These may be fixed type or portable type, it is automatically record the total number of vehicle crossing a section of the road in a desired period.
- Other methods of working the mechanical detectors are by videos, radar detector.
- Advantage is that it can work throughout the day and night for the desired period.

- Manual count

- It is possible to obtain data which can not be collected by mechanical counter such as vehicle classification, turning movement.

## Presentation of traffic volume data

- Average annual flow: (veh/year)
- Annual average daily traffic(AADT or ADT): Average daily traffic (ADT) represents the total traffic for a year divided by 365, or the average traffic volume per day.(veh/day)
- Hourly average traffic: (veh/hr)
- Thirtieth highest hourly volume or the **design hourly volume** is found from the plot between hourly volume and the number of hours in a year that the traffic volume is exceeded. The 30<sup>th</sup> highest hourly volume is the hourly volume that will be exceeded only 29 times in a year and all other hourly volumes of the years will be less than this volume. The 30<sup>th</sup> highest traffic volume is found to be satisfactory from both facility and economic considerations.

# SPEED STUDY

- **Spot speed**:- it is the instantaneous speed of a vehicle at a specified location.
- **Average speed**:- it is the average of spot speed of all vehicles passing at given points on the highway.
- **Space mean speed**:- (harmonic mean) Average speed of vehicles in a certain road length at a given instant.

$$V_s = \frac{n}{\sum_{i=1}^n \frac{1}{V_i}}$$

Where,

$V_s$  = space mean speed

$n$  = no. of vehicles

$V$  = speed of the vehicle

$$V_s = \frac{nL}{\sum_{i=1}^n t_i}$$



## Time mean speed:-(arithmetic mean)

- Mean speed of vehicle at a point in space over a period of time or It is the average of instantaneous speeds of observed vehicles at the spot.

$$V_t = \frac{\sum_{i=1}^n V_i}{n}$$

Where,

$V_t$ = time mean speed

$n$ = no. of vehicles

$V$ = speed of the vehicle

- **Running speed:-** it is the average speed maintained by a vehicle over a particular stretch of road, while the vehicle is in motion ; this is obtained by dividing the distance covered by the time during which the vehicle is actually in motion.
- **Journey speed or travel speed:-** it is the effective speed with which a vehicle traverse a particular route between two terminals, it includes delay and stoppages.

# Types of speed study

1. Spot speed study
2. Speed and delay study

## Use of spot speed study

- To use in planning traffic control and in traffic regulation.
- To use in geometric design for redesigning the existing highway.
- To use in accident studies.
- To study the traffic capacity.

## Speed and delay study

- The speed and delay studies give the running speeds, overall speeds, fluctuations in speeds and the delay between two stations of a road.
- It gives the information such as the amount, location, duration and cause of delay in the traffic stream.
- The result of the spot and delay studies are useful in detecting the spot of congestion.
- The delay or time lost traffic during the travel period may be either due to fixed delays or operational delays.
- Fixed delay occurs primarily at intersections due to traffic signals and at level crossings.
- Operational delays are caused by the interference of traffic movement, such as turning vehicles, parking vehicles, pedestrians ..etc.

## Presentation of spot speed data

- A graph is plotted with the average value of each speed group on X-axis and the cumulative percent of vehicles travelled at or below the different speeds on Y-axis. From the graph(i.e. Cumulative frequency distribution curve) followings can be obtained.

- 98<sup>th</sup> percentile speed-Design speed
- 85<sup>th</sup> percentile speed-Maximum speed
- 50<sup>th</sup> percentile speed-Median speed
- 15<sup>th</sup> percentile speed-Minimum speed

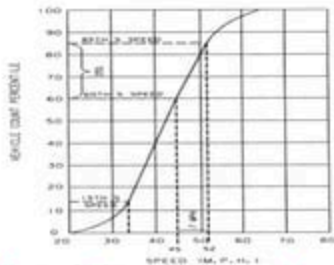

- **Modal average speed(frequency distribution curve):**
  - A frequency curve of spot speed is plotted with average value of each speed group of vehicle in X-axis and the percentage of vehicle in that group on the Y-axis.
  - The speed corresponding to peak value of curve is denoted as modal speed

## Methods of speed and delay study

- Floating car or riding check method
- License plate or vehicle number method
- Interview method
- Elevated observations
- Photographic technique

## Floating car or riding check method

- In the floating car method a **test vehicle** is driven over a given course of travel at approximately the average speed of the stream, thus trying to float with the traffic stream. A number of test runs are made along the study stretch and a group of observers record the various details. **One observer** is seated in the floating car with **two stop watches**. One of the stop watch is used to record the time at various control point like intersections, bridges or any other fixed points in each trip.
- The other stop watch is used to find the duration of the individual delays. The time, location and cause of these delays are recorded by the **second observer**.
- the number of vehicle overtaking the test vehicle and the overtaken by the test vehicle are noted in each trip by **third observer**.
- The no. of vehicles travelling in the opposite direction in each trip is noted by **fourth observer**.
- In this method the detailed information is obtained concerning all phases of speed and delay including location, duration and causes of delay.

## Floating car or riding check method

$$\bar{t} = t_w - \frac{n_y}{q}$$

$$q = \frac{n_a + n_y}{t_a + t_w}$$

where,

$\bar{t}$  = average journey time in minute

$q$  = flow of vehicle (average volume) in one direction of the stream

$n_a$  = average number of vehicles counted in the direction of the Stream when the test vehicle travels in the opposite directions

$n_y$  = the average no. of vehicles overtaking the test vehicle minus the no. of vehicles overtaken when the test is in the direction of 'q'

$T_w$  = average journey time, in minute when the test vehicle is travelling with the stream 'q'

$T_a$  = average journey time, in minute when test vehicle is running against the stream 'q'

### Example-1

The consolidated data collected from speed and delay studies by floating car method on a stretch of urban road of length 3.5 km, running North- South are given below. Determine the average values of volume, journey speed and running speed of the traffic stream along either direction.

Trip No.	Direction of trip	Journey time Min- Sec	Total stop delay Min- Sec	No. of vehicles overtaking	No. of vehicle overtaken	No. of vehicles from opposite direction
1	N-S	6-32	1-40	4	7	268
2	S-N	7-14	1-50	5	3	186
3	N-S	6-50	1-30	5	3	280
4	S-N	7-40	2-00	2	1	200
5	N-S	6-10	1-10	3	5	250
6	S-N	8-00	2-22	2	2	170
7	N-S	6-28	1-40	2	5	290
8	S-N	7-30	1-40	3	2	160



# solution

direction	Journey time Min- Sec	stopped delay Min- Sec	Number of vehicle		
			overtaking	overtaken	In opposite direction
<b>N-S</b>	6-32	1-40	4	7	268
	6-50	1-30	5	3	280
	6-10	1-10	3	5	250
	6-28	1-40	2	5	290
<b>TOTAL</b>					
<b>Mean</b>					
<b>S-N</b>	7-14	1-50	5	3	186
	7-40	2-00	2	1	200
	8-00	2-22	2	2	170
	7-30	1-40	3	2	160
	<b>TOTAL</b>				
<b>Mean</b>					

# Origin and destination studies

- The object of this study is
  - Plan the road network and other facilities for vehicular traffic
  - Plan the schedule of different modes of transportation for the trip demand of commuters.
- It gives the information like the actual direction of travel, selection of routes and length of trip.
- Used in planning new highway facilities and in improving some of the existing system.
- To plan the transportation system and mass transit facilities in cities including route and schedules of operation
- To locate expressway or major routes along the desire lines.
- To locate terminals and to plan terminal facilities.

## Cont...

- To locate new bridge as per traffic demands.
- To locate intermediate stops of public transport.

### Methods of 'O' and 'D' survey:

- Road- side interview method
- License plate method
- Return post card method
- Tag-on-car method
- Home interview method

## Traffic flow characteristics and studies

- The basic traffic maneuvers are **diverging, merging, crossing and weaving**.
- Traffic Flow( $q$ ):- the rate at which vehicles pass at a fix point (vehicles per hour) =  $N(3600/t)$ .
- Traffic Density( $k$ ):- no. of vehicles( $N$ ) over a stretch of roadway( $L$ ) i.e. vehicles per kilometer =  $N/L$
- Time headway:- Time interval between the passage of the fronts of the successive vehicles at a specified point.

## Cont...

- Average time headway= average travel time per unit distance x average space headway

Space headway:- distance between front of successive vehicles.

- Average space headway= space mean speed x average time headway

### Flow Density Relationship

- Flow= density x space mean speed
  - ❖  $q = K \times V$
- Density = 1/ space headway
  - ❖  $1/h_s$
- Space mean speed = flow x Space headway
  - ❖  $q \times h_s$
- Density = flow x time per unit distance
  - ❖  $K = q \times t$

# Traffic capacity studies

## Traffic capacity:

- The ability of a roadway to accommodate traffic volume. It is expressed as the maximum number of vehicle in a lane or a road that can pass a given point in unit time, usually an hour.
- Volume represent an actual rate of flow where as capacity indicates a maximum rate of flow with a certain level of service.

## Basic capacity:

- It is the maximum no. of passenger car that can be pass a given point on a roadway during one hour under the most nearly ideal roadway and traffic conditions. It is otherwise known as theoretical capacity.

## Possible capacity:

- It is the maximum no. vehicle that can pass a given point on a roadway during one hour under prevailing roadway and traffic conditions.

## Practical capacity:

- It is the maximum no. of vehicle that can pass a given point on a roadway during one hour, without traffic density being so great as to cause unreasonable delay, hazard or restriction to the driver freedom to maneuver under the prevailing roadway and traffic conditions.
- $C = 1000 V/S$
- $S$  = average spacing of vehicle in m,  $C$  is the capacity in vehicle per hour per lane.

## Peak-Hour Factor

- It is basically represent the variation in traffic flow with in an hour.
- Observations of traffic flow consistently indicate that the flow rates are found in the peak.
- A 15 minute period within an hour is not sustained through out the entire period and that is why we need to use the peak-hour factor.
- Normally on freeways the peak-hour factor values range from 0.80 to 0.95.



## Passenger Car Unit (PCU)

- The different vehicle classes have a wide range of static characteristics and dynamic characteristics, apart from these the driver behavior of the different vehicle classes is also found to vary considerable. Therefore mixed traffic flow characteristics are very much complex when compare to homogeneous traffic and it is difficult to estimate the traffic volume , capacity of roadway under the mixed traffic flow, unless the different vehicle classes are converted to one common standard vehicle unit.
- Therefore it is a common practice to consider the passenger car as the standard vehicle unit to convert the other vehicle classes and this unit is called passenger car unit.

PCU value depends upon the several factors, such as:

- Vehicle characteristics
- Transverse and longitudinal gaps or clearance between moving vehicles.
- Speed distribution of the mixed traffic stream, volume to capacity ratio.
- Roadway characteristics.
- Regulation and control of traffic.
- Environmental and climatic conditions.

# Passenger car equivalency factor(PCU)

- As per IRC:86-1983

S.L. No.	Vehicle class	Equivalency factor
1	Motor cycle, Scooter and Pedal cycle	0.5
2	Passenger car, Tempo, auto rickshaw, Agricultural tractor, Pick-up van	1.0
3	Cycle -rickshaw	1.5
4	Truck, Bus, Agricultural tractor-trailer	3.0
5	Horse-drawn vehicle	4.0
6	Small bullock-cart and Hand-cart	6.0
7	Large bullock-cart	8.0

# Relation between speed, travel time, volume, density and capacity

Refer page no.-208,209 and 210 of highway Engg.  
by S.K. Khanna & C.E.G Justo

## Cont...

- Maximum flow occurs when the speed is  $V_{sf}/2$  and the density is  $K_j/2$

$$q_{\max} = \frac{V_{sf} \times K_j}{4}$$

- Where,
- $K_j$  = jam density= 1000/spacing of vehicle
- $V_{sf}$  = free mean speed
- $K = q/v$
- $q$  = average volume of vehicle, (veh./hr)
- $V$  = space mean speed of vehicle, kmph

# Level of service(LOS)

- It is define as a qualitative measure describing the operational condition within a traffic stream, and their perception by motorist and passengers.
- Or Rating of acceptable level of congestion
- LOS definitions
  - **A:** Free flow, low traffic, high speed
  - **B:** Stable flow, noticeable traffic
  - **C:** Stable flow, traffic interactions,
  - **D:** Unstable flow, High density, movement restrictions
  - **E:** Unstable flow, lower speed, volume is nearly equal to capacity, little freedom
  - **F:** Unstable flow, no freedom, traffic volume can drop to zero, stop & go

## Cont...

### LOS- A

- ✓ Free-flow operation
- ✓ no restriction in maneuvering.



### LOS- B

- ✓ Reasonably free flow
- ✓ Ability to maneuver is only slightly restricted
- ✓ Effects of minor incidents still easily absorbed



## Cont....

### LOS- C

- ✓ Speeds at or near FFS
- ✓ Freedom to maneuver is noticeably restricted
- ✓ Queues may form behind any significant blockage.



### LOS- D

- ✓ Speeds decline slightly with increasing flows
- ✓ Density increases more quickly
- ✓ Freedom to maneuver is more noticeably limited
- ✓ Minor incidents create queuing





# Cont...

## LOS- E

- ✓ Operation near or at capacity
- ✓ No usable gaps in the traffic stream
- ✓ Operations extremely volatile
- ✓ Any disruption causes queuing



## LOS- F

- ✓ Breakdown in flow
- ✓ Queues form behind breakdown points
- ✓ Demand > capacity



## In India, As per IRC

LOS- B: for design of Rural Roads

LOS- C: for the design of Urban Roads

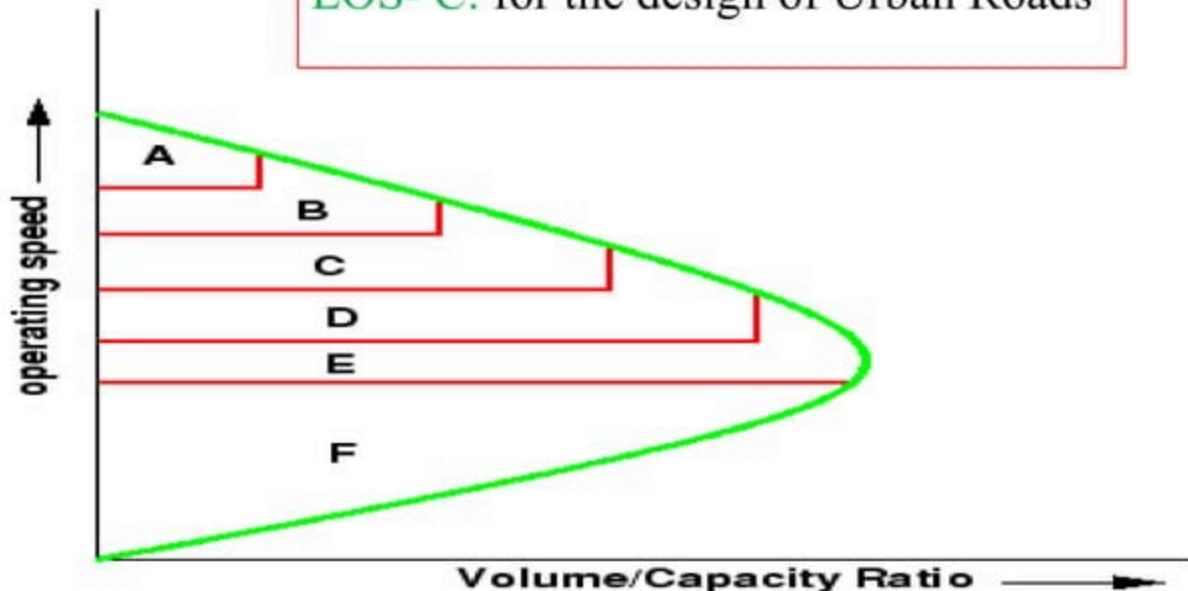

# Traffic operations

- Number of conflicts at intersection
  - Crossing conflicts
  - Merging conflicts
  - Diverging conflicts

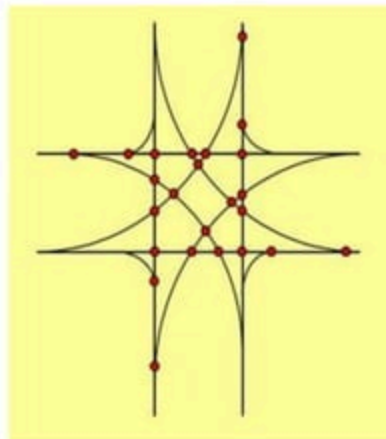

Number of lanes		Number of potential conflicts		
Road- A	Road- B	Both road two-way	A- Oneway B- twoway	Both roads Oneway
2	2	24	11	6
2	3	24	11	8
2	4	32	17	10
3	3	24	13	11
4	4	44	25	18

# Bibliography

- Khanna, S. K., & Justo, C. E. G. *“Highway engineering”*. Nem Chand & Bros.
- *IRC Codes*.